

Startup Guide

Keysight M9391A PXIe Vector Signal Analyzer and M9381A PXIe Vector Signal Generator 1 MHz to 3 GHz or 6 GHz.

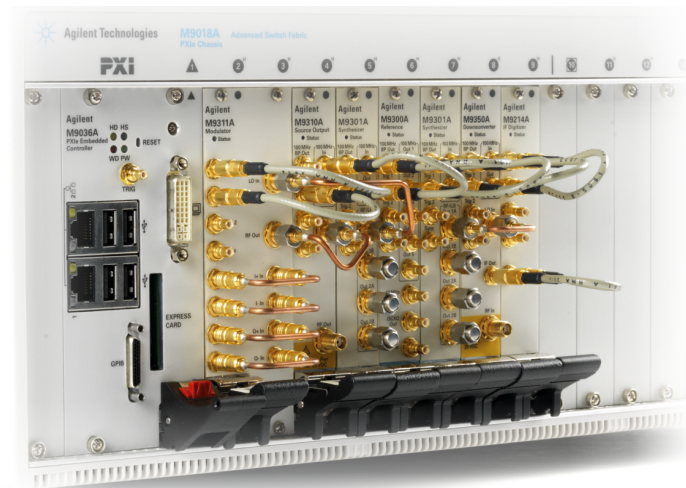

Notice: This document contains references to Agilent. Please note that Agilent's Test and Measurement business has become Keysight Technologies. For more information, go to www.keysight.com.

Notices

© Keysight Technologies, Inc. 2013, 2014

No part of this manual may be reproduced in any form or by any means (including electronic storage and retrieval or translation into a foreign language) without prior agreement and written consent from Keysight

Technologies, Inc. as governed by United States and international copyright laws.

Manual Part Number
M9300-90090

Edition

October 2014. Build 2014.10.27.1501

Sales and Technical Support

For product specific information and support, and to obtain the latest software and documentation, refer to

www.keysight.com/find/pxi-mimo.

Worldwide contact information for repair and service can be found at

www.keysight.com/find/assist.

Information on preventing damage to your Keysight equipment can be found at

www.keysight.com/find/tips.

Regulatory Compliance

This product has been designed and tested in accordance with accepted industry standards, and has been supplied in a safe condition. To review the Declaration of Conformity, go to

<http://regulations.corporate.keysight.com/DoC/search.htm>.

Warranty

The material contained in this document is provided “as is,” and is subject to being changed, without notice, in future editions. Further, to the maximum extent permitted by applicable law, Keysight disclaims all warranties, either express or implied, with regard to this manual and any information contained herein, including but not limited to the implied warranties of merchantability and fitness for a particular purpose. Keysight shall not be liable for errors or for incidental or consequential damages in connection with

the furnishing, use, or performance of this document or of any information contained herein. Should Keysight and the user have a separate written agreement with warranty terms covering the material in this document that conflict with these terms, the warranty terms in the separate agreement shall control. Keysight Technologies does not warrant third-party system-level (combination of chassis, controllers, modules, etc.) performance, safety, or regulatory compliance, unless specifically stated.

Technology Licenses

The hardware and/or software described in this document are furnished under a license and may be used or copied only in accordance with the terms of such license.

Restricted Rights Legend

If software is for use in the performance of a U.S. Government prime contract or sub-contract, Software is delivered and licensed as “Commercial computer software” as defined in DFAR 252.227-7014 (June 1995), or as a “commercial item” as defined in FAR 2.101(a) or as “Restricted computer software” as defined in FAR 52.227-19 (June 1987) or any equivalent agency regulation or contract clause. Use, duplication or disclosure of Software is subject to Keysight Technologies’ standard commercial license terms, and non-DOD Departments and Agencies of the U.S. Government will receive no greater than Restricted Rights as defined in FAR 52.227-19(c)(1-2) (June 1987). U.S. Government users will receive no greater than Limited Rights as defined in FAR 52.227-14 (June 1987) or DFAR 252.227-7015 (b)(2) (November 1995), as applicable in any technical data.

Safety Notices

The following safety precautions should be observed before using this product and any associated instrumentation.

This product is intended for use by qualified personnel who recognize shock hazards and are familiar with the safety precautions required to avoid possible injury. Read and follow all installation, operation, and maintenance information carefully before using the product.

WARNING

If this product is not used as specified, the

protection provided by the equipment could be impaired. This product must be used in a normal condition (in which all means for protection are intact) only.

The types of product users are:

- **Responsible body** is the individual or group responsible for the use and maintenance of equipment, for ensuring that the equipment is operated within its specifications and operating limits, and for ensuring operators are adequately trained.
- **Operators** use the product for its intended function. They must be trained in electrical safety procedures and proper use of the instrument. They must be protected from electric shock and contact with hazardous live circuits.
- **Maintenance personnel** perform routine procedures on the product to keep it operating properly (for example, setting the line voltage or replacing consumable materials). Maintenance procedures are described in the user documentation. The procedures explicitly state if the operator may perform them. Otherwise, they should be performed only by service personnel.
- **Service personnel** are trained to work on live circuits, perform safe installations, and repair products. Only properly trained service personnel may perform installation and service procedures.

WARNING

Operator is responsible to maintain safe operating conditions. To ensure safe operating conditions, modules should not be operated beyond the full temperature range specified in the Environmental and physical specification. Exceeding safe operating conditions can result in shorter lifespans, improper module performance and user safety issues. When the modules are in use and operation within the specified full temperature range is not maintained, module

surface temperatures may exceed safe handling conditions which can cause discomfort or burns if touched. In the event of a module exceeding the full temperature range, always allow the module to cool before touching or removing modules from chassis. Keysight products are designed for use with electrical signals that are rated Measurement Category I and Measurement Category II, as described in the International Electrotechnical Commission (IEC) Standard IEC 60664. Most measurement, control, and data I/O signals are Measurement Category I and must not be directly connected to mains voltage or to voltage sources with high transient over-voltages. Measurement Category II connections require protection for high transient over-voltages often associated with local AC mains connections. Assume all measurement, control, and data I/O connections are for connection to Category I sources unless otherwise marked or described in the user documentation.

Exercise extreme caution when a shock hazard is present. Lethal voltage may be present on cable connector jacks or test fixtures. The American National Standards Institute (ANSI) states that a shock hazard exists when voltage levels greater than 30V RMS, 42.4V peak, or 60VDC are present. A good safety practice is to expect that hazardous voltage is present in any unknown circuit before measuring.

Operators of this product must be protected from electric shock at all times. The responsible body must ensure that operators are prevented access and/or insulated from every connection point. In some cases, connections must be exposed to potential human contact. Product operators in these circumstances must be trained to protect themselves from the risk of electric shock. If the circuit is capable of operating at or above 1000V, no conductive part of the circuit may be exposed.

Do not connect switching cards directly to unlimited power circuits. They are intended to be used with impedance-limited sources.

NEVER connect switching cards directly to AC mains. When connecting sources to switching cards, install protective devices to limit fault current and voltage to the card.

Before operating an instrument, ensure that the line cord is connected to a properly-grounded power receptacle. Inspect the connecting cables, test leads, and jumpers for possible wear, cracks, or breaks before each use.

When installing equipment where access to the main power cord is restricted, such as rack mounting, a separate main input power disconnect device must be provided in close proximity to the equipment and within easy reach of the operator.

For maximum safety, do not touch the product, test cables, or any other instruments while power is applied to the circuit under test. ALWAYS remove power from the entire test system and discharge any capacitors before: connecting or disconnecting cables or jumpers, installing or removing switching cards, or making internal changes, such as installing or removing jumpers.

Do not touch any object that could provide a current path to the common side of the circuit under test or power line (earth) ground.

Always make measurements with dry hands while standing on a dry, insulated surface capable of withstanding the voltage being measured.

The instrument and accessories must be used in accordance with its specifications and operating instructions, or the safety of the equipment may be impaired.

Do not exceed the maximum signal levels of the instruments and accessories, as defined in the specifications and operating information, and as shown on the instrument or test fixture panels, or switching card.

When fuses are used in a product, replace with the same type and rating for continued protection against fire hazard.

Chassis connections must only be used as shield connections for measuring circuits, NOT as safety earth ground connections.

If you are using a test fixture, keep the lid closed while power is applied to the device under test. Safe operation requires the use of a lid interlock.

CAUTION

A **CAUTION** notice denotes a hazard. It calls attention to an operating procedure, practice, or the like that, if not correctly performed or adhered to, could result in damage to the product or loss of important data. Do not

proceed beyond a **CAUTION** notice until the indicated conditions are fully understood and met.

WARNING

A **WARNING** notice denotes a hazard. It calls attention to an operating procedure, practice, or the like that, if not correctly performed or adhered to, could result in personal injury or death. Do not proceed beyond a **WARNING** notice until the indicated conditions are fully understood and met.

Instrumentation and accessories shall not be connected to humans.

Before performing any maintenance, disconnect the line cord and all test cables.

To maintain protection from electric shock and fire, replacement components in mains circuits – including the power transformer, test leads, and input jacks – must be purchased from Keysight. Standard fuses with applicable national safety approvals may be used if the rating and type are the same. Other components that are not safety-related may be purchased from other suppliers as long as they are equivalent to the original component (note that selected parts should be purchased only through Keysight to maintain accuracy and functionality of the product). If you are unsure about the applicability of a replacement component, call an Keysight office for information.

WARNING

No operator serviceable parts inside. Refer servicing to qualified personnel. To prevent electrical shock do not remove covers. For continued protection against fire hazard, replace fuse with same type and rating.

PRODUCT MARKINGS:



The CE mark is a registered trademark of the European Community.



Australian Communication and Media Authority mark to indicate regulatory compliance as a registered supplier.

ICES/NMB-001
ISM GRP.1 CLASS A

This symbol indicates product compliance with the Canadian Interference-Causing Equipment Standard (ICES-001). It also identifies the product is an Industrial Scientific and Medical Group 1 Class A product (CISPR 11, Clause 4).



South Korean Class A EMC Declaration. This equipment is Class A suitable for professional use and is for use in electromagnetic environments outside of the home. A급 기기 (업무용 방송통신기자재) 이 기기는 업무용 (A급) 전자파적합기기로서 판매자 또는 사용자는 이 점을 주의하시기 바라며, 가정외의 지역에서 사용하는 것을 목적으로 합니다.



This symbol indicates separate collection for electrical and electronic equipment, mandated under EU law as of August 13, 2005. All electric and electronic equipment are required to be separated from normal waste for disposal (Reference WEEE Directive, 2002/96/EC).



This symbol indicates the instrument is sensitive to electrostatic discharge (ESD). ESD can damage the highly sensitive components in your instrument. ESD damage is most likely to occur as the module is being installed or when cables are connected or disconnected. Protect the circuits from ESD damage by wearing a grounding strap that provides a high resistance path to ground. Alternatively, ground yourself to discharge any built-up static charge by touching the outer shell of any grounded instrument chassis before touching the port connectors.



This symbol on an instrument means caution, risk of danger. You should refer to the operating instructions located in the user doc-

umentation in all cases where the symbol is marked on the instrument.



This symbol indicates the time period during which no hazardous or toxic substance elements are expected to leak or deteriorate during normal use. Forty years is the expected useful life of the product.

CLEANING PRECAUTIONS:

WARNING

To prevent electrical shock, disconnect the Keysight Technologies instrument from mains before cleaning. Use a dry cloth or one slightly dampened with water to clean the external case parts. Do not attempt to clean internally. To clean the connectors, use alcohol in a well-ventilated area. Allow all residual alcohol moisture to evaporate, and the fumes to dissipate prior to energizing the instrument.

Table of Contents

Documentation Map	9
Introduction	10
Follow the Startup Sequence	10
Related Documentation	11
Step 1: Unpack and Inspect the Modules	12
Inspect for Damage	12
Return an Instrument for Service	12
Step 2: Verify Shipment Contents and Model Options	13
Step 3: Install the Software	17
Power up the Controller	17
Software Installation Overview	18
Software Installation Procedure	18
Step 4: Install the Modules	19
Recommended best practices to ensure proper and safe module operating conditions	19
Module Installation Process Overview	20
M9381A Instrument Connections	22
M9391A Instrument Connections	24
M9391A Instrument Connections with M9381A VSG	26
Sharing the M9300A Frequency Reference	27
Module Front Panel Features	30
M9300A Front Panel Connectors	30
M9214A Front Panel Connectors	35
M3991A Block Diagram	36
Block Diagram Reference Tables	37
M9391A Block Diagram Reference Table for M9300A	37
M9391A Block Diagram Reference Table for M9301A	37
M9391A Block Diagram Reference Table for M9350A	38
M9391A Block Diagram Reference Table for M9214A	38
M9381A Block Diagram	39
M9381A Block Diagram Reference Table for M9300A	39
M9381A Block Diagram Reference Table for M9301A	40
M9381A Block Diagram Reference Table for M9310A	40
M9381A Block Diagram Reference Table for M9311A	41
Step 5: Verify Operation of the M9381A Vector Signal Generator and M9393A PXIe Vector Signal Analyzer ...	42
Communications	45
Step 6: Make a Measurement	46
Step 7: Installation is Complete	47
API Overview	47
SCPI Interface (M9380A and M9381A only)	48
M9391A and M9381A Specifications	48
Configuring M9018A PXIe Backplane Triggers	49
Keysight 89600 Vector Signal Analysis Software for M9391A	51
Procedure for a Single Channel Configuration	52

Documentation Map

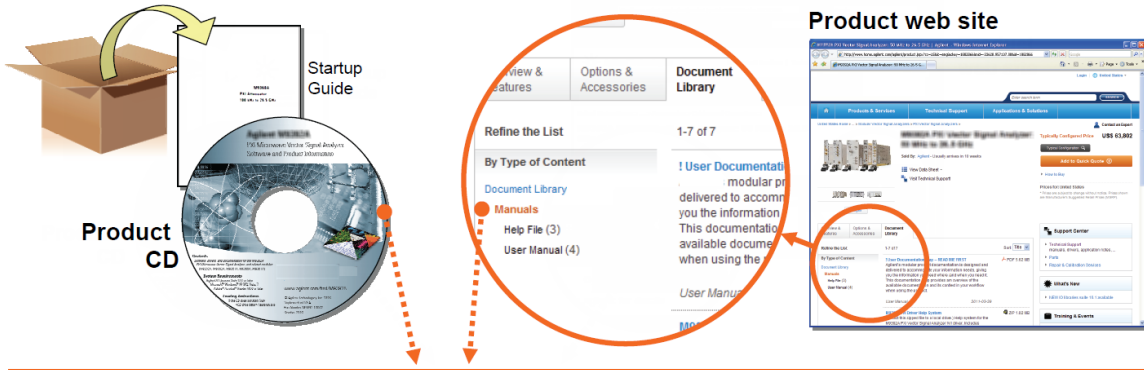

Access to all **DOCUMENTATION** noted below

Startup Guide



- Unpack product
- Verify shipment
- Install software
- Install & connect hardware
- Verify operation
- Troubleshooting

Data Sheet/Specs Guide



Technical specifications

Programming Guide



- Tutorials
- Code examples
- Measurement examples
- Programming tips

Soft Front Panel (SFP) user interface

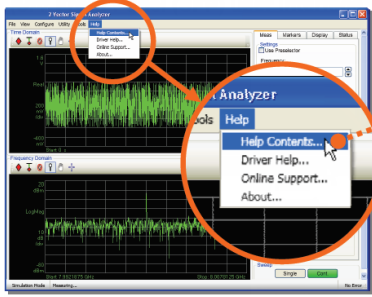

SFP help system

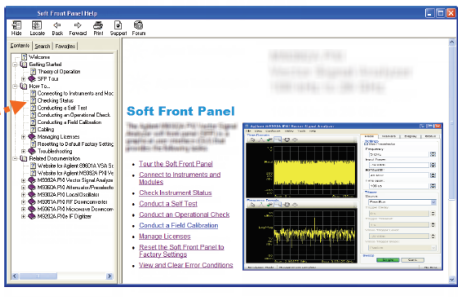

- Theory of operation
- Block diagram
- Configuration
- Self test
- Operational check
- Troubleshooting
- Measurements (limited)
- Field calibration

Visual Studio

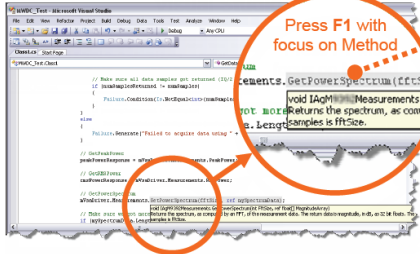

Press F1 with focus on Method

IVI Driver help system

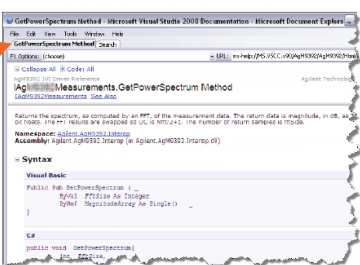

- IVI-COM and IVI-C driver programmer's reference
- Sample programs

LabVIEW

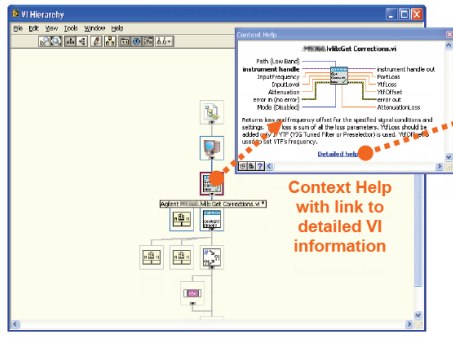

Context Help with link to detailed VI information

LabVIEW Driver help system

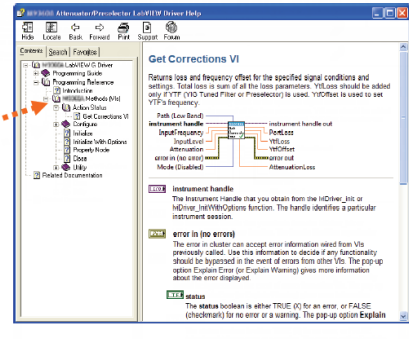

- LabVIEW driver programmer's reference
- Sample programs

Introduction

The scope of this Startup Guide is to detail the processes of receiving and installing the modules and cables that compose the Keysight M9381A PXIe Vector Signal Generator and the Keysight M9391A PXIe Vector Signal Analyzer. Additionally, installing the required software is documented. If you have any questions after reviewing this information, please contact your local Keysight Technologies Inc. representative or contact us through our website at www.Keysight.com/find/pxi-vsag.

Follow the Startup Sequence

WARNING Closely follow the startup process flow in this document. Deviating from the sequence can cause unpredictable system behavior, damage your system, and may cause personal injury.

Step 1: Unpack and Inspect



Step 2: Verify Shipment



Step 3: Install Drivers and Software

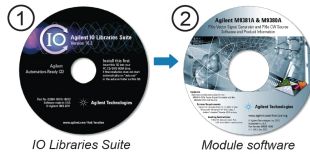

Step 4: Install Module

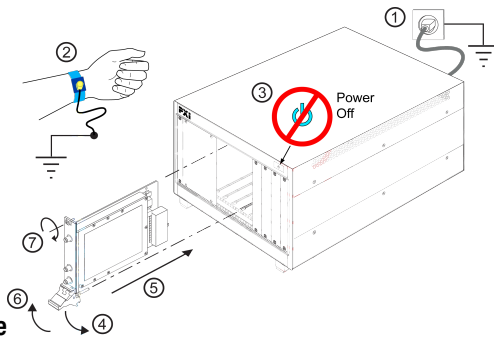

Step 5: Verify Operation with the Soft Front Panel (SFP)



Step 6: Make a Measurement



Step 7: INSTALLATION COMPLETE.

Proceed to program your product through the API.

Related Documentation

The documentation associated with this product is available at the respective product pages on keysight.com (go to **Document Library** > **Manuals**).

M9381A Vector Signal Generator (see www.keysight.com/find/M9381A)

- M9381A VSG and M9391A VSA Startup Guide
- M9381A VSG and M9391A VSA Programming Guide
- M9381A Soft Front Panel help system
- M9381A device driver API references (IVI-C/IVI-COM and LabVIEW G)
- M9381A Data Sheet
- M9381A Specifications Guide

M9391A Vector Signal Analyzer (see www.keysight.com/find/M9391A)

- M9391A Soft Front Panel help system
- M9391A device driver API references (IVI-C/IVI-COM and LabVIEW G)
- M9391A and M9393A Data Sheet
- M9391A and M9393A Specifications Guide

The Keysight M9381A, M9380A and M9391A Security Guide is available at www.cp.-literature.keysight.com/litweb/pdf/M9300-90021.pdf.

If you are using your Keysight M9381A VSG and Keysight M9391A VSA for MIMO measurements please refer to the Keysight MIMO PXI Test Solution Startup Guide at www.cp.-literature.keysight.com/litweb/pdf/Y1299-90001.pdf.

NOTE If you ordered the M9391A VSA with the M9300A RF Reference (order option M9391-300) and did not order the M9381A VSG or M9380A CW Source, be aware that the M9300A software and documentation are not installed with the M9391A installer. To install the M9300A software and documentation, run the M938x installer, available at www.keysight.com/find/M9381A-driver. (When you run the M938x installer, you have the option to install only the M9300A-related files.)

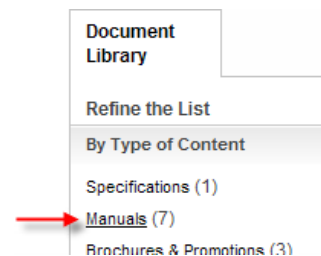

Step 1: Unpack and Inspect the Modules

CAUTION The modules are shipped in materials which prevent damage from static. The module should only be removed from the packaging in an anti-static area ensuring that correct anti-static precautions are taken. Store all modules in anti-static envelopes when not in use.

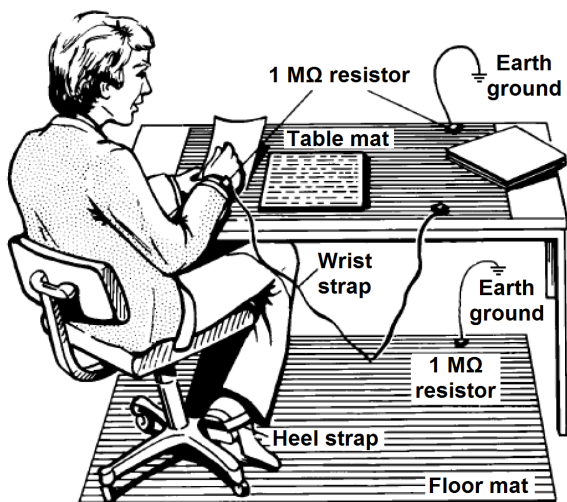

Electrostatic discharge (ESD) can damage or destroy electronic components. Use a static-safe work station to perform all work on electronic assemblies. The figure (left) shows a static-safe work station using two types of ESD protection: conductive table-mat and wrist-strap combination, and conductive floor-mat and heel-strap combination. Both types, when used together, provide a significant level of ESD protection. Of the two, only the table-mat and wrist-strap combination provides adequate ESD protection when used alone. To ensure user safety, the static-safe accessories must provide at least 1 MΩ of isolation from ground.

WARNING DO NOT use these techniques for a static-safe work station when working on circuitry with a voltage potential greater

than 500 volts.

Inspect for Damage

After unpacking an instrument, inspect it for any shipping damage. Report any damage to the shipping agent immediately, as such damage is not covered by the warranty (see warranty information at beginning of this document).

CAUTION To avoid damage when handling a module, do not touch exposed connector pins.

NOTE See www.keysight.com/find/tips for information on preventing damage to your keysight equipment.

Return an Instrument for Service

Should it become necessary to return an instrument for repair or service, follow the steps below:

NOTE It is recommended that you return all modules and cables of the M9381A or M9391A instrument for repair and calibration. If your Keysight M9300A PXIe Frequency Reference is operating properly, you need not send it in with the other modules because your instrument may be repaired and calibrated without your M9300A. Doing so, however, will effect your calibration schedule, since repairs are followed by calibration. The Calibration Due Date for your M9300A will not match the date of your other modules.

1. Review the warranty information shipped with your product.

2. Contact Keysight to obtain a Return Material Authorization (RMA) and return address. For assistance finding Keysight contact information, go to www.keysight.com/find/assist.
3. Write the following information on a tag and attach it to the malfunctioning equipment:
 - Name and address of owner. A P.O. box is not acceptable as a return address.
 - Module serial number(s). The serial number label is located on the side panel of the module. The serial number can also be read from the Soft Front Panel interface – after the hardware is installed.
 - Description of failure or service required.
4. Pack the instrument in its original packaging. Include all cables. If the original packaging material is not available, use anti-static bubble wrap or packing peanuts and place the instrument in a sealed container and mark the container “FRAGILE”.
5. On the shipping label, write ATTENTION REPAIR DEPARTMENT and the RMA number.

NOTE In your correspondence, refer to the modules by serial number and the instrument by model number.

Step 2: Verify Shipment Contents and Model Options

M9381A Shipment Contents

The Keysight M9381A PXIe Vector Signal Generator is a multi-module instrument (MMI), housed in a PXIe chassis. The minimum Vector Signal Generator consists of the software, chassis, an Keysight M9301A PXIe Synthesizer, an Keysight M9310A PXIe Source Output, an Keysight M9311A PXIe Digital Vector Modulator and an Keysight M9300A PXIe Frequency Reference. The M9300A may be used in this and other configurations. You may configure the Keysight M9380A PXIe CW Source in the same chassis and also use the same M9300A.

Items included in your M9381A Shipment

Qty	Part Number	Description
1	M9300-10002	Software and Product Information CD, contains: Soft Front Panels, drivers, and all printed documentation in PDF format. (also available at http://www.keysight.com/find/m9381a)
1	E2094-60003	Keysight IO Libraries Suite CD
1	M9300-90090	Keysight M9391A PXIe Vector Signal Analyzer and M9381A PXIe Vector Signal Generator Startup Guide in hard copy
1	5023-1450	Wrench, socket, extension, 5/16 inch, SMA
1	5002-3361	SMB/MMCX Cable Removal Tool
3	1810-0118	SMA (m) straight, 50 Ω termination. These are attached to the M9301A RF/LO ports.
1 *	M9300A	(Optional) Keysight M9300A PXIe Frequency Reference
1 *	M9300-90001	(Optional) M9300A Startup Guide (ships with M9300A)
1	M9301A	Keysight M9301A PXIe Synthesizer
1	M9310A	Keysight M9310A PXIe Source Output

Step 2: Verify Shipment Contents and Model Options

Qty	Part Number	Description
1	M9311A	Keysight M9311A PXIe Digital Vector Modulator
1	5972-3335	PXI Modular Product Startup Guide Reference
1	9320-6691	China ROHS Addendum for Signal Generator
1	5962-0476	Certificate of Calibration
1	5959-4660	Recommended Due Date for Adjustment/Calibration
1 *	8121-2063	(Optional) Cable, coaxial, BNC/male-SMB/female, 1200 mm (ships with M9300A)
1	8121-2175	Cable, coaxial, SMB/female SMB/female (300 mm)
4	8120-5091	Cable, coaxial, SMB-SMB (120 mm)
1	1250-2316	Adaptor, coaxial, straight, SMA (f) to SMA (m)
1	W1312-20266	Cable, semi-rigid, (SMA-SMA)
1	W1312-20267	Cable, semi-rigid, (SMA-SMA)
4	W1312-20265	Cable, coaxial, SMB-SMB (85 mm)

Model – Option List for the Keysight M9381A PXIe Vector Signal Generator

M9381A	Description
M9381A	PXIe C W Source: 1 MHz to 3 GHz or 6 GHz
M9381A-F03	Frequency Range, 1 MHz to 3 GHz
M9381A-F06	Frequency Range: 1 MHz to 6 GHz
M9381A-1EA	High Output Power
M9381A-UNZ	Fast Switching
M9381A-B04	RF Modulation Bandwidth, 40 MHz
M9381A-B10	RF Modulation Bandwidth, 100 MHz
M9381A-B16	RF Modulation Bandwidth, 160 MHz
M9381A-M01	Memory, 32 MSa
M9381A-M05	Memory, 512 MSa
M9381A-M10	Memory, 1024 MSa
M9381A-UNT	Analog Modulation
M9381A-300	Keysight M9300A PXIe Frequency Reference: 10 MHz and 100 MHz
M9381A-UK6	Commercial calibration certificate with test data

M9391A Shipment Contents

Items included in your Keysight M9391A PXIe Vector Signal Analyzer Shipment

Qty	Keysight Part Number	Description
1	M9300-10002	Software and Product Information CD, contains: Soft Front Panels, drivers, and all printed documentation in PDF format (also available at www.keysight.com/find/m9391a)
1	E2094-60003	Keysight IO Libraries Suite CD
1	M9300-90090	Keysight M9391A PXIe Vector Signal Analyzer and M9381A PXIe Vector Signal Generator Startup Guide in hard copy
1	5962-0476	Certificate of Calibration
1	5959-4660	Recommended Due Date for Adjustment/Calibration
1	5023-1450	Wrench, socket, extension, 5/16 inch, SMA
1	5002-3361	Cable removal tool, SMB/MMCX
1	5972-3335	PXI Modular Product Startup Quick Reference
1	9320-6698	China RoHS Addendum for Vector Signal Analyzer
1	M9300A	(Optional) Keysight M9300A PXIe Frequency Reference
1	M9300-90001	(Optional) M9300A Startup Guide (ships with M9300A)
3	1810-0118	SMA (m) straight, 50 Ω termination. These are attached to the M9301A RF/LO ports.
1	M9301A	Keysight M9301A PXIe Synthesizer
1	M9350A	Keysight M9350A PXIe Downconverter
1	M9214A	Keysight M9214A PXIe IF Digitizer
1	8121-2063	(Optional) Cable, coaxial, BNC/male-SMB/female, 1200 mm (ships with M9300A)
4	8120-5091	Cable, coaxial, SMB/female-SMB/female (120 mm)
1	8121-2100	Cable, coaxial SMB/female SMB/female (85 mm)
1	8121-2175	Cable, coaxial, SMB/female SMB/female (300 mm)
1	W1312-20237	Cable, semi-rigid, SMA/male-SMA/male, 32mm
3	1250-2316	Adaptor, coaxial straight, male-SMA to female SMA

* The Keysight M9300A PXIe Frequency Reference is required to configure an Keysight M9381A PXIe Vector Signal Generator. It is an option to the M9381A because it may be ordered in, and shared by the M9380A or the M9391A instrument.

Step 2: Verify Shipment Contents and Model Options

Model – Option List for the Keysight M9391A PXIe Vector Signal Analyzer

M9391A	Description
M9391A	PXIe Vector Signal Analyzer: 1 MHz to 3 GHz or 6 GHz
M9391A-F03	Frequency Range, 1 MHz to 3 GHz
M9391A-F06	Frequency Range: 1 MHz to 6 GHz
M9391A-UNZ	Fast Switching
M9391A-B04	Analysis Bandwidth, 40 MHz
M9391A-B10	Analysis Bandwidth, 100 MHz
M9391A-B16	Analysis Bandwidth, 160 MHz
M9391A-M01	Memory, 32 MSa
M9391A-M05	Memory, 512 MSa
M9391A-M10	Memory, 1024 MSa
M9391A-300	Add Keysight M9300A PXIe Frequency Reference: 10 MHz and 100 MHz
M9391A-UK6	Commercial calibration certificate with test data

Step 3: Install the Software

System Requirements

Topic	Windows 7 Requirements
Operating system	Windows 7 (32 bit and 64 bit), WES7
Processor speed	1 GHz 32-bit (x86), 1 GHz 64-bit (x64), no support for Itanium64
Available memory	4 GB minimum (8 GB recommended for 64-bit operating systems) ²
Available disk space	3 1.5 GB available hard disk space, includes: <ul style="list-style-type: none"> • 1 GB available for Microsoft .NET Framework 3.5 SP1 4 • 100 MB for Keysight IO Libraries Suite
Video	Support for DirectX 9 graphics with 128 MB graphics memory recommended (Super VGA graphics is supported)
Browser	Microsoft Internet Explorer 7.0 or greater

Hardware Requirements

Topic	Requirements
Chassis	PXle or PXI-H chassis slot
Controllers	A PXI or PXI Express embedded controller or remote controller (external PC connected to the chassis by a PCI-to-PXI interface) is required.
Embedded controller	Keysight M9036A or M9307A or an embedded controller that meets the following requirements: <ul style="list-style-type: none"> • PXle system controller (PXI-1 embedded controllers are not compatible) • Utilize a 2x8, or 4x4 PXle system slot link configuration. • Run one of the operating systems listed in System Requirements (above).
Remote controller	(for Keysight M9018A chassis use only) A PC running one of the operating systems listed in System Requirements above and a Keysight M9021A Cable Interface x8 with one of the following PC interface options: <ul style="list-style-type: none"> • Keysight M9045B PCIe ExpressCard Adaptor x1, with cable (for a laptop PC) • Keysight M9048A PCIe Desktop Adaptor x8, with cable (for desktop PCs)

Power up the Controller

CAUTION

If you are using a remote controller and you have installed the interface cable, you must power up the chassis BEFORE you power up the PC. When you power down your chassis, Shut Down the PC BEFORE you power down the chassis.

If you are using an embedded controller, complete the following steps:

1. Install the embedded controller module into the compatible chassis. The Keysight M9036A PXle Embedded Controller and Keysight M9018A PXle Chassis are recommended. Please refer to the embedded controller and chassis documentation for further details.
2. Connect peripherals (mouse, keyboard, monitor).
3. Power up the chassis.

Software Installation Overview

This installation includes the following:

- Keysight IO Libraries Suite (IOLS), which includes the Keysight Connection Expert. This software is included with your shipment (CD part number E2094-60003), and is also available at www.keysight.com/find/iosuite. This software must be installed first.

NOTE Version 16.3.16603.3 (or newer) of the Keysight IO Libraries Suite is required.

- Instrument software, which includes the soft front panel (SFP), device drivers (IVI-C, IVI-COM, and LabVIEW G) and documentation for the M9381A PXIe Vector Signal Generator and M9391A PXIe Vector Signal Analyzer. This software is included with your shipment (CD part number M9300-10002) and is also available at .

Software Installation Procedure

1. Install the Keysight IO Libraries Suite from the Keysight IO Libraries Suite CD (E2094-60003) provided in your ship kit. Follow the installer prompts to install the IO libraries.
2. Install the product software:
 - a. Using the Keysight PXIe VSA & VSG Software and Product Information CD (M9300-10002), launch the installer.
 - b. Follow the installer prompts. Choose a "Complete" installation to install all software and documentation, or a "Custom" installation to select from a listing of modules and other features.

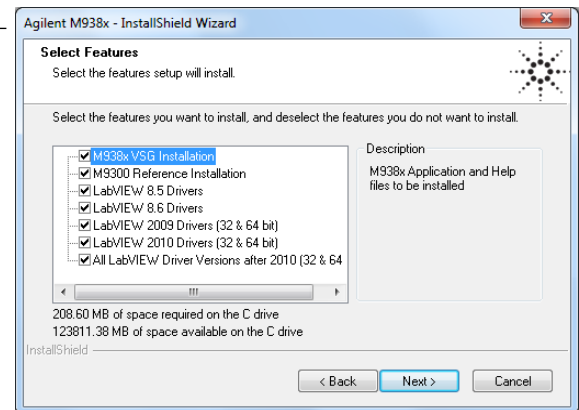

3. Complete the installation

Embedded controller M9036A, M9037A):

- a. Select "Yes, I want to restart my computer now."
This is the default selection.

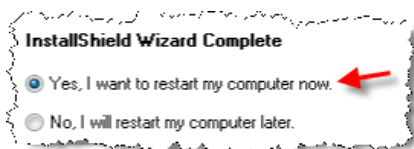

- b. Click on **Finish**.
- c. Wait for the system to restart.

Remote controller:

(Follow these steps in order, or else instrument damage may result.)

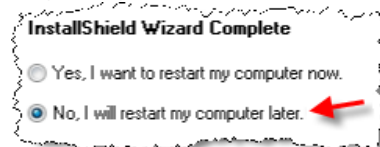

- b. Click on **Finish**.
- c. Shut down the remote controller PC. Use **Start > Shut down**.
- d. Power down the chassis.
- e. Power up the chassis.

- f. Power up the remote controller PC.

Step 4: Install the Modules

CAUTION PXI hardware does not support "hot-swap" (changing modules while power is applied to the chassis) capabilities. Before installing or removing a module to/from the chassis, power off the chassis to prevent damage to the module.

NOTE All component modules for an M9381A or M9391A instrument are factory tested, aligned, calibrated and shipped as a "bundle". It is important that you maintain the bundle when installing modules or returning an instrument for repair.

NOTE These modules can be used in a chassis with PXIe or PXI-H chassis slots.

Recommended best practices to ensure proper and safe module operating conditions

- Ensure proper chassis air flow is maintained
- Select a chassis that provides thermal protection if fans become inoperable or forced air cooling is obstructed
- Use slot blockers (Keysight model [Y1212A](#), 5 per kit) and EMC filler panels in empty module slots to ensure proper operating temperatures. Keysight chassis [Keysight M9018A chassis](#) and slot blockers optimize module temperature performance and reliability of test.
- Set chassis fans to high or auto. Do not disable fans.
- Position chassis to allow plenty of space around chassis air intake and fan exhaust.
- At environment temperatures above 45 °C, set chassis fan speed to high.

M9018A Chassis Air Flow



Step 4: Install the Modules

The M9018A has multiple air intakes. They are located at the lower sides, lower front, and bottom of the chassis.

Module Installation Process Overview



The module can be installed in any PXIe or hybrid PXI slot marked with a peripheral slot compatibility image (solid black circle for PXIe, or solid black circle with the letter “H” for hybrid).

1. Make sure that the line cord is plugged in to establish earth ground and that the chassis power switch is **Off**.
2. If the chassis has multiple fan speed settings, ensure that the fan switch is set to **AUTO** and the inhibit switch is set to **DEF**.



3. Position the chassis to provide ample space between the chassis fan intake and exhaust vents. Blockage by walls or obstructions affects the air flow needed for cooling. (Refer to the chassis documentation for more information about cooling).
4. Before inserting a module into the chassis, back the mounting screws out to ensure that there is no interference between the screws and the mounting rails.
 - Single M9381A instrument: see [M9381A Instrument Connections \(page 22\)](#)
 - Single M9391A instrument: see [M9391A Instrument Connections \(page 24\)](#)
 - Integrated M9391A plus M9381A: see [M9391A Instrument Connections with M9381A VSG \(page 26\)](#).
5. See "[M9391A Instrument Connections](#)" on page 24 for positioning the M9391A modules. See "[M9381A Instrument Connections](#)" on page 22 for positioning the M9381A modules.

CAUTION

The M9381A uses peer-to-peer (module-to-module) triggering across the PXI Express chassis backplane. Therefore, be sure to install the M9381A modules into a chassis that supports peer-to-peer PXI Express I/O switch topology. When using the Keysight M9018A PXIe 18-Slot Chassis, install the M9381A modules into one of its three slot groups: 1 through 6, 7 through 12, or 13 through 18. Unless you install the M9381A modules entirely within one of the slot groups, you will experience trigger errors. If you install the modules across (straddling) any of these groups of slots, you will have to reconfigure the chassis's PXIe trigger bus routing for trigger 6 and trigger 7. (EXCEPTION: You can install the M9300A Reference module in a different slot group, thus allowing one M9300A module to provide an RF reference across slot groups to one or more modular instruments.) For details on reconfiguring the M9018A chassis triggers see "[Configuring M9018A PXIe Backplane Triggers](#)" on page 49, or see the [Keysight M9018A Chassis documentation](#). If you are using a non-Keysight chassis, consult your manufacturer's documentation.

NOTE When using the Keysight M9018A Chassis you will achieve the highest data throughput for the Keysight M9391A PXIe Vector Signal Analyzer by using Slots 2, 6, 11 or 15 for the Keysight M9214A PXIe IF Digitizer. They are "x8" slots and the others are "x4". For further details see the [Keysight M9018A Chassis documentation](#). If you are using a non-Keysight chassis, consult your manufacturer's documentation.

6. Holding the module by the injector/ejector handle, slide it into an available PXI (or hybrid) slot, as shown in the following figure.

- a. Install the module into the slot of the chassis by placing the module card edges into the front module guides (top and bottom).
- b. Slide the module to the rear of the chassis and ensure that the injector/ejector handle is pushed down in the unlatched (downward) position.
- c. Slide the module completely into the chassis. When you begin to feel resistance, pull up on the injector/ejector handle to fully inject the module into the chassis.

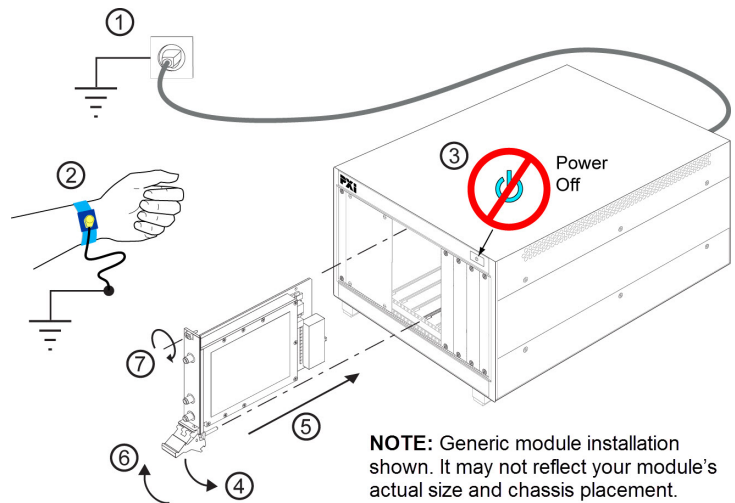

7. Secure all modules to the chassis using the module mounting screws. Use a #1 Pozidriv® or a slotted screwdriver and torque to 5 Lb-In (0.57 N-m). Performance may suffer if the screws are not tightened properly.
8. Verify that the PXI chassis fans are operable and free of dust and other contaminants that may restrict airflow.
9. Install filler panels and slot blockers after installing the modules. Missing filler panels or slot blockers may disrupt air circulation in the chassis. The left-most slot does not accept a slot blocker.
10. Your shipment included an Keysight M9310A PXIe Source Output and an Keysight M9350A PXIe Downconverter. With these modules you received a straight, coaxial adapter (1250-2316) (SMA female to SMA male). Connect this adapter to the RF Out connector of each M9310A and the RF In connector of each M9350A, and torque to 8 Lb-In (0.904 Nm). **This will extend the life of these often-used connectors.**
11. Use the [M9391A Instrument Connections with M9381A VSG \(page 26\)](#) to attach the cables to the instrument. The torque specification for SMA connectors is 8 Lb-In (0.904 Nm).
12. If you are using a PCIe Cable Interface, such as the Keysight M9021, connect the Cable Interface in the chassis to the PC host per the instructions that came with the Cable Interface.
13. Power up the PXI chassis.
14. Remap the backplane triggers, if necessary. See ["Configuring M9018A PXIe Backplane Triggers" on page 49](#)
15. If you are using a remote PC, reboot the PC host.
16. Proceed to [Step 5: Verify Operation of the M9381A Vector Signal Generator and M9393A PXIe Vector Signal Analyzer \(page 42\)](#).

M9381A Instrument Connections

This section contains a cabling diagram for the Keysight M9381A PXIe Vector Signal Generator, a cable and module association table, a table of Front Panel Features for each module, and a block diagram for the M9381A, with reference tables for each module.

NOTE If you are building an M9381A VSA plus an M9391A VSG, see "M9391A Instrument Connections with M9381A VSG" on page 26.

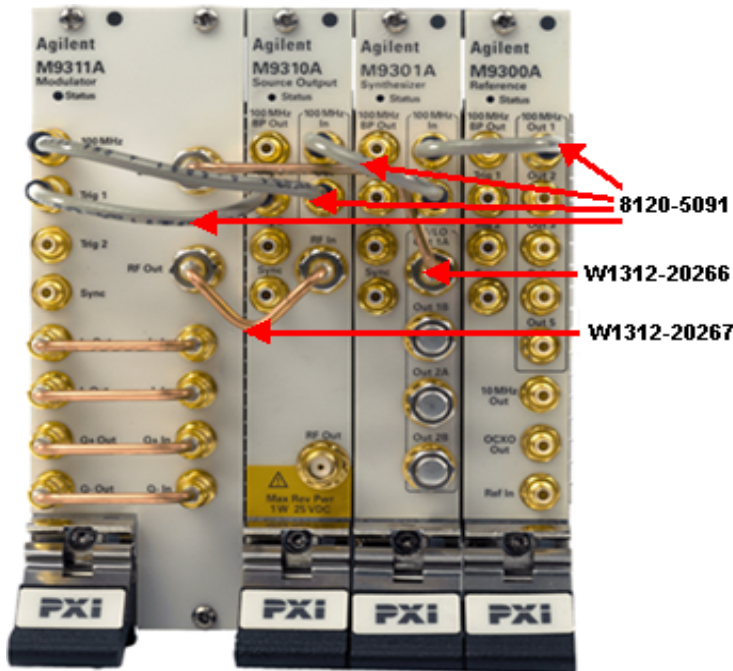

Recommendation: Install the semi-rigid cables first.

For front panel feature descriptions of the M9300A, see "M9300A Front Panel Connectors" on page 30.

For front panel feature descriptions of the M9301A, See "For parameter limits and specifications on the M9301A connectors, see M9391A Block Diagram Reference Table for M9301A (page 37)." on page 30.

For front panel feature descriptions of the M9310A, see "M9310A Front Panel Connectors" on page 32.

For front panel feature descriptions of the M9311A, see "M9311A Front Panel Connectors" on page 33.

M9381A Cable and Module Table

Part Number	Connection	Cable Description
8121-2063	This cable can be used to direct an External Reference into the M9300A Ref In connector.	Cable, coaxial, BNC (male) - SMB (female), 1200 mm
1250-2316	M9310A RF Out connector saver	Adaptor, coaxial, straight SMA (male) - SMA (female)
8121-2175	M9311A Trig 2 to M9214A Trig 1 *	Cable, coaxial, SMB (female)-SMB (female) 300 mm
8120-5091	M9300A 100 MHz Out 1 to M9301A 100 MHz In	Cable, coaxial, SMB (female)-SMB (female)
8120-5091	M9301A 100 MHz Out to M9310A 100 MHz In	Cable, coaxial, SMB (female)-SMB (female)
8120-5091	M9310A 100 MHz Out to M9311A 100 MHz In	Cable, coaxial, SMB (female)-SMB (female)

Part Number	Connection	Cable Description
8120-5091	M9310A Trig 1 to M9311A Trig 1 for Pulse Modulation	Cable, coaxial, SMB (female)-SMB (female)
W1312-20266	M9301A RF/LO Out 1A to M9311A LO In	Cable, semi-rigid, SMA (male) - SMA (male)
W1312-20267	M9311A RF Out to M9310A RF In	Cable, semi-rigid, SMA (male) - SMA (male)

Torque specification for all SMA connectors is 8 Lb-In (0.904 Nm).

NOTE *The 8121-2175 cable is not required for standard M9381A operation. It is useful for power amplifier (PA) testing with the M9391A. This cable improves repeatability by enabling you to consistently measure the same portion of the input signal.

M9391A Instrument Connections

This section contains a cabling diagram for the Keysight M9391A PXIe Vector Signal Analyzer, a cable and module association table, a table of Front Panel Features for each module, and a block diagram for the M9391A, with reference tables for each module.

NOTE If you are building an M9381A VSA plus an M9391A VSG, see "M9391A Instrument Connections with M9381A VSG" on page 26.

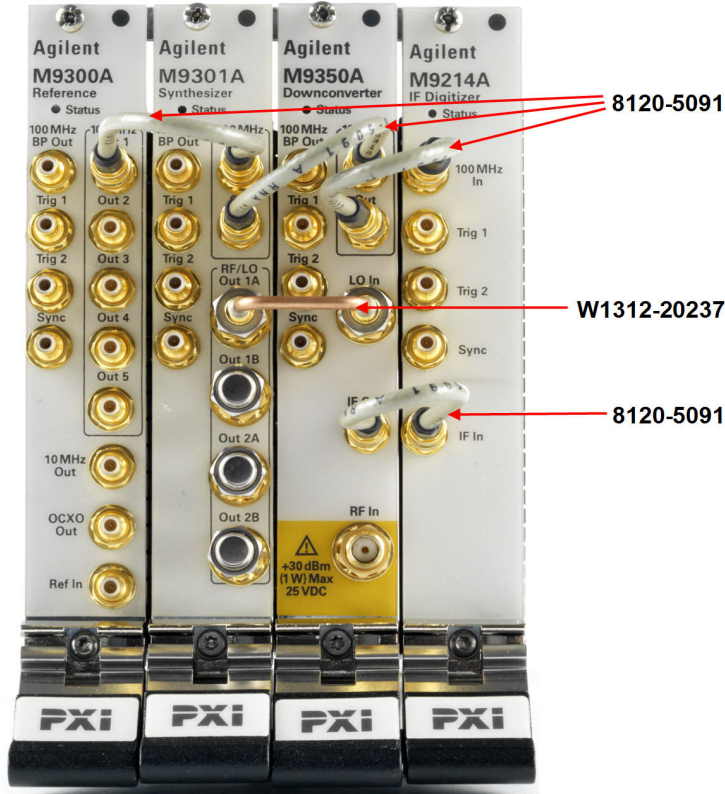

Recommendation: Install the semi-rigid cable first.

For front panel feature descriptions of the M9300A, see [M9300A Front Panel Connectors](#) (page 30).

For front panel feature descriptions of the M9301A, see [For parameter limits and specifications on the M9301A connectors](#), see [M9391A Block Diagram Reference Table for M9301A](#) (page 37). (page 30).

For front panel feature descriptions of the M9350A, see [M9350A Front Panel Connectors](#) (page 34).

For front panel feature descriptions of the M9214A, see [M9214A Front Panel Connectors](#) (page 35).

M9391A Cable and Module Table

Part Number	Connection	Cable Description
1250-23161	M9350A RF In connector saver	Adaptor, coaxial straight SMA (male) - SMA (female)
8121-20631	This cable can be used to direct an External Reference into the M9300A Ref In connector.	Cable, coaxial, BNC (male) - SMB (female) 1200 mm
8120-5091	M9300A 100 MHz Out 1 to M9301A 100 MHz In	Cable, coaxial, SMB (female) - SMB (female) 120 mm
8120-5091	M9301A 100 MHz Out to M9350A 100 MHz In	Cable, coaxial, SMB (female) - SMB (female) 120 mm
8120-5091	M9350A 100 MHz Out to M9214A 100 MHz In	Cable, coaxial, SMB (female) - SMB (female) 120 mm
8120-5091	M9350A IF Out to M9214A IF In	Cable, coaxial, SMB (female) - SMB (female) 120 mm

Part Number	Connection	Cable Description
W1312-20237	M9301A RF/LO Out 1A to M9350A LO In	Cable, semi-rigid, SMA (male) - SMA (male)

Torque specification for all SMA connectors is 8 Lb-In (0.904 Nm).

Step 4: Install the Modules

M9391A Instrument Connections with M9381A VSG

This section contains a cabling diagram for the Keysight M9391A PXIe Vector Signal Analyzer with an Keysight M9381A PXIe Vector Signal Generator.

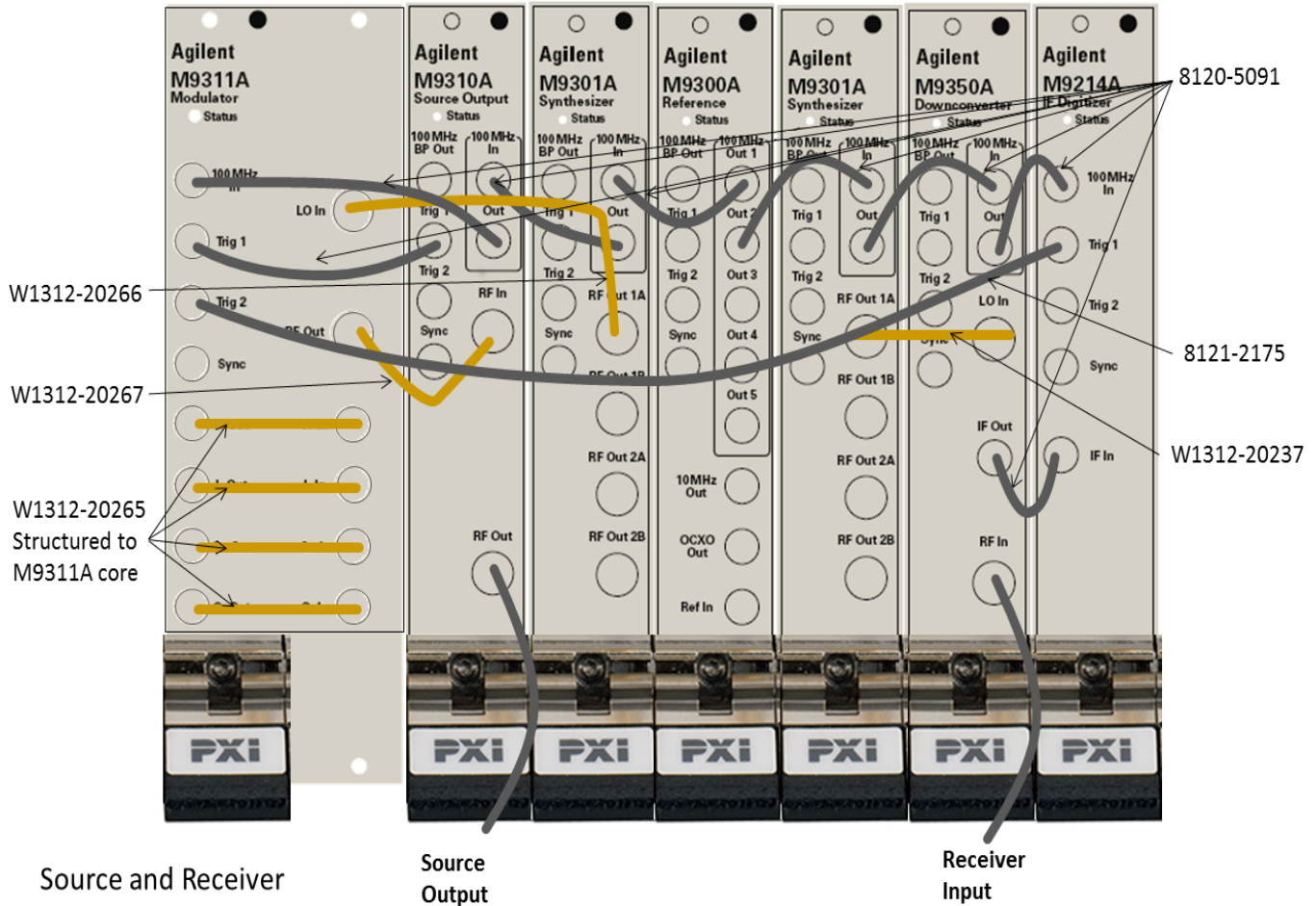

Sharing the M9300A Frequency Reference

The M9300A Frequency Reference module can be shared by the all M9391A and M9381A instruments in your solution. If you connect to a hardware configuration that includes a currently connected M9300A (either independently or as part of another hardware configuration) the latest instance of the SFP will take control of the M9300A. You will see no warning or error message.

CAUTION While the M9300A module is being shared, any of the configurations that share this reference can control it fully, including setting the reference to use an external frequency reference source. If the external frequency reference setting does not match that of the supplied frequency, the reference will be unlocked, as expected. However, only the instance of the SFP that creates the reference unlock condition can correct the problem. This is done by either correcting the frequency or by setting the reference back to internal, so that a subsequent instance will not take control of the reference module unintentionally.

CAUTION The Reference module can also be shared among multiple measurement applications, such as the Keysight 89600 VSA software. The Reference module must be initialized before use, so including it in all configurations allows applications to be started in any order. However, when sharing a module the user interface of some applications may not reflect M9300A settings made by other applications. For example, the Keysight 89600 software can control the Reference module internal/external setting, but the changes made by other applications will not be reflected in the Keysight 89600.

NOTE FPGA updates are not allowed on a Keysight M9300A PXIe Frequency Reference while it is being shared. To perform M9300A FPGA updates, reserve the Reference.

Reserving the Reference for a Configuration

If you are running a test in the background with a certain M9300A setting and then connect a hardware configuration that also contains the same M9300A, you may alter the test setup that is already running.

If you would prefer to be keep the reference control with the first instance of the hardware configuration so that a subsequent instance will not take control of the reference module unintentionally:

1. On the SFP Connect to Instrument screen, click the **Advanced** control to open the **Options:** dialog.
2. Type the following string: `ShareReferenceVisaSession=0`

This configuration will retain control of the M9300A if you try to open a new configuration. If you connect a new configuration, that includes the same M9300A, you will see the following error:

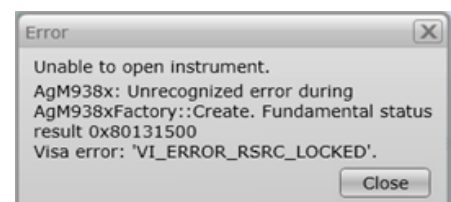
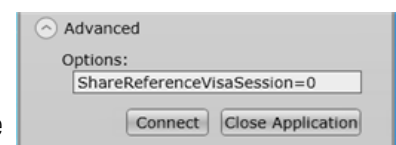

Step 4: Install the Modules

CAUTION

If an existing instance of the SFP is connected to the reference module in a shared (default) mode, and you try to connect a second instance of the SFP to the same reference with `ShareReferenceVisaSession=0` Advanced Option, you will get the resource locked error shown above.

Cable and Connector Care

Use the Keysight Cable Removal Tool to disconnect push-on cables from the module front panel connectors.

CAUTION To avoid damage to the cables or connectors, pull the cable straight away from the connector. Do not use the tool as a pry bar.

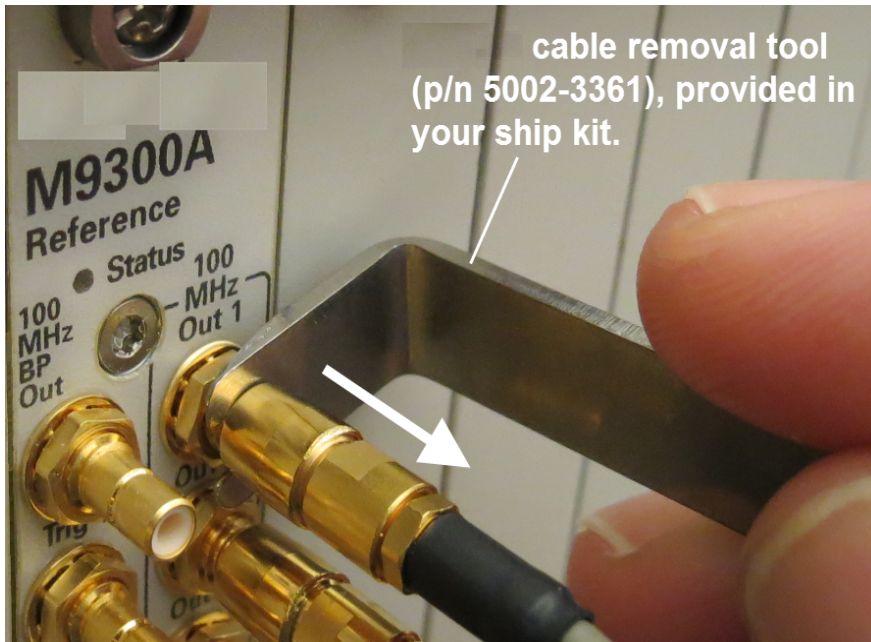

Module Front Panel Features

M9300A Front Panel Connectors

For parameter limits and specifications on the M9300A, see [M9391A Block Diagram Reference Table for M9300A \(page 37\)](#).

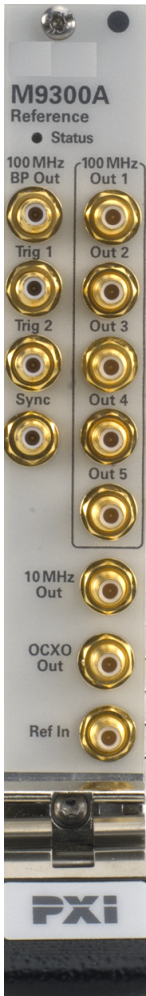

Connector	Description
100 MHz BP Out	This SMB male connector outputs a 100 MHz signal from the chassis backplane board. This output is enabled through the SFP.
100 MHz Out 1 through Out 5	Each of these SMB male connectors may output a 100 MHz reference and clock signal to the 100 MHz In connector of the Keysight M9301A PXIe Synthesizer.
Trig 1	This connector is intended for future use.
Trig 2	This connector provides a programmable output trigger.
Sync	This connector is intended for future use.
10 MHz Out	This SMB male connector provides a 10 MHz signal. This output is enabled through the SFP.
OCXO Out	This SMB male connector provides a 10 MHz signal from the 10 MHz OCXO timebase. This output is enabled through the SFP.
Ref In	This SMB male connector inputs a 1 MHz to 110 MHz reference signal. The connector is AC coupled and terminated into 50 Ω.

For parameter limits and specifications on the M9301A connectors, see [M9391A Block Diagram Reference Table for M9301A \(page 37\)](#).



Connector	Description
100 MHz BP Out	This SMB male connector outputs a 100 MHz signal from the chassis backplane.
100 MHz In	This SMB male connector inputs a 100 MHz reference and clock signal from the 100 MHz Out connectors of the Keysight M9300A PXIe Frequency Reference.
100 MHz Out	This SMB male connector outputs the 100 MHz Reference signal.
Trig 1	
Trig 2	This SMB male connector is the End of Acquisition Output.
Sync	This connector is intended for future use.
RF/LO Out 1A, 1B, 2A, 2B	These SMA female connectors (1A and 1B) are used to provide the RF In signal to the Keysight M9310A PXIe Source Output. Connectors 2A and 2B are intended for future use. Unused connectors should be terminated with the provided 50 Ω loads.

Step 4: Install the Modules

M9310A Front Panel Connectors

For parameter limits and specifications on the M9310A connectors, see [M9381A Block Diagram Reference Table for M9310A](#) (page 40).



Connector	Description
100 MHz BP Out	This SMB male connector outputs a 100 MHz signal from the chassis backplane.
100 MHz In	This SMB male connector inputs a 100 MHz reference signal.
100 MHz Out	This SMB male connector outputs the 100 MHz Reference signal.
Trig 1	This SMB male connector accepts the Pulse RF Blanking Input Trigger from the M9311A Trig 1 connector.
Trig 2	This SMB male connector is the Source Settled Output Trigger.
Sync	This connector is intended for future use.
RF In	This SMA female connector inputs the RF signal from the Keysight M9311A PXIe Digital Vector Modulator RF Out connector.
RF Out	This SMA female connector outputs a RF signal of 1 MHz to 3 GHz or 6 GHz.

CAUTION To avoid damage, do not exceed 1 Watt (25 VDC) reverse power into the M9310A RF Out connector.

M9311A Front Panel Connectors

For parameter limits and specifications on the M9311A connectors, see [M9381A Block Diagram Reference Table for M9311A \(page 41\)](#).

Connector	Description
100 MHz In	This SMB male connector inputs a 100 MHz reference signal.
LO In	This SMA female connector inputs the LO signal from the Keysight M9301A PXIe Synthesizer RF/LO Out connector.
Trig 1	This SMB male connector is the Pulse RF Blanking Output Trigger. The Pulse Modulation trigger is received by the M9310A Trig 1 connector.
Trig 2	This SMB male connector is the Synchronization Output Trigger.
Sync	This connector is intended for future use.
RF Out	This SMA female connector outputs a modulated RF signal of 1 MHz to 3 GHz or 6 GHz. This signal is routed to the M9310A RF In connector.

CAUTION Do not remove or replace any of the four IQ cables at the bottom of the module.

Step 4: Install the Modules

M9350A Front Panel Connectors

For parameter limits and specifications on the M9350A connectors, see [M9391A Block Diagram Reference Table for M9350A \(page 38\)](#).

	Connector	Description
 <p>Agilent M9350A Downconverter ● Status</p> <p>100 MHz BP Out</p> <p>100 MHz In</p> <p>Trig 1 Out</p> <p>Trig 2</p> <p>Sync</p> <p>LO In</p> <p>IF Out</p> <p>RF In</p> <p>+30 dBm 11W Max 25VDC</p> <p>PXI</p>	100 MHz BP Out	This SMB male connector outputs a 100 MHz signal from the chassis backplane board. This output is enabled through the SFP.
	Trig 1	This connector is intended for future use.
	Trig 2	Receiver Armed Output.
	Sync	This connector is intended for future use.
	100 MHz In	This SMB male connector inputs a 100 MHz reference signal from the 100 MHz Out connector of the Keysight M9301A PXIe Synthesizer.
	100 MHz Out	This SMB male connector outputs the 100 MHz In signal to the Keysight M9214A PXIe IF Digitizer 100 MHz In connector.
	LO In	This SMA female connector inputs the LO signal from the Keysight M9301A PXIe Synthesizer RF/LO Out connector.
	IF Out	This SMB male connector sends the IF signal to the M9214A IF Input.
	RF In	This SMA female connector inputs a modulated RF signal of 1 MHz to 6 GHz.

M9214A Front Panel Connectors

For parameter limits and specifications on the M9214A connectors, see [M9391A Block Diagram Reference Table for M9214A \(page 38\)](#).



Connector	Description
100 MHz In	This SMB male connector inputs a 100 MHz reference signal from the 100 MHz Out connector of the .
Trig 1	External Trigger Input.
Trig 2	Trigger Received Output.
Sync	This connector is intended for future use.
IF In	This SMB male connector accepts the IF Input from the M9350A IF Out connector.

Step 4: Install the Modules

M3991A Block Diagram

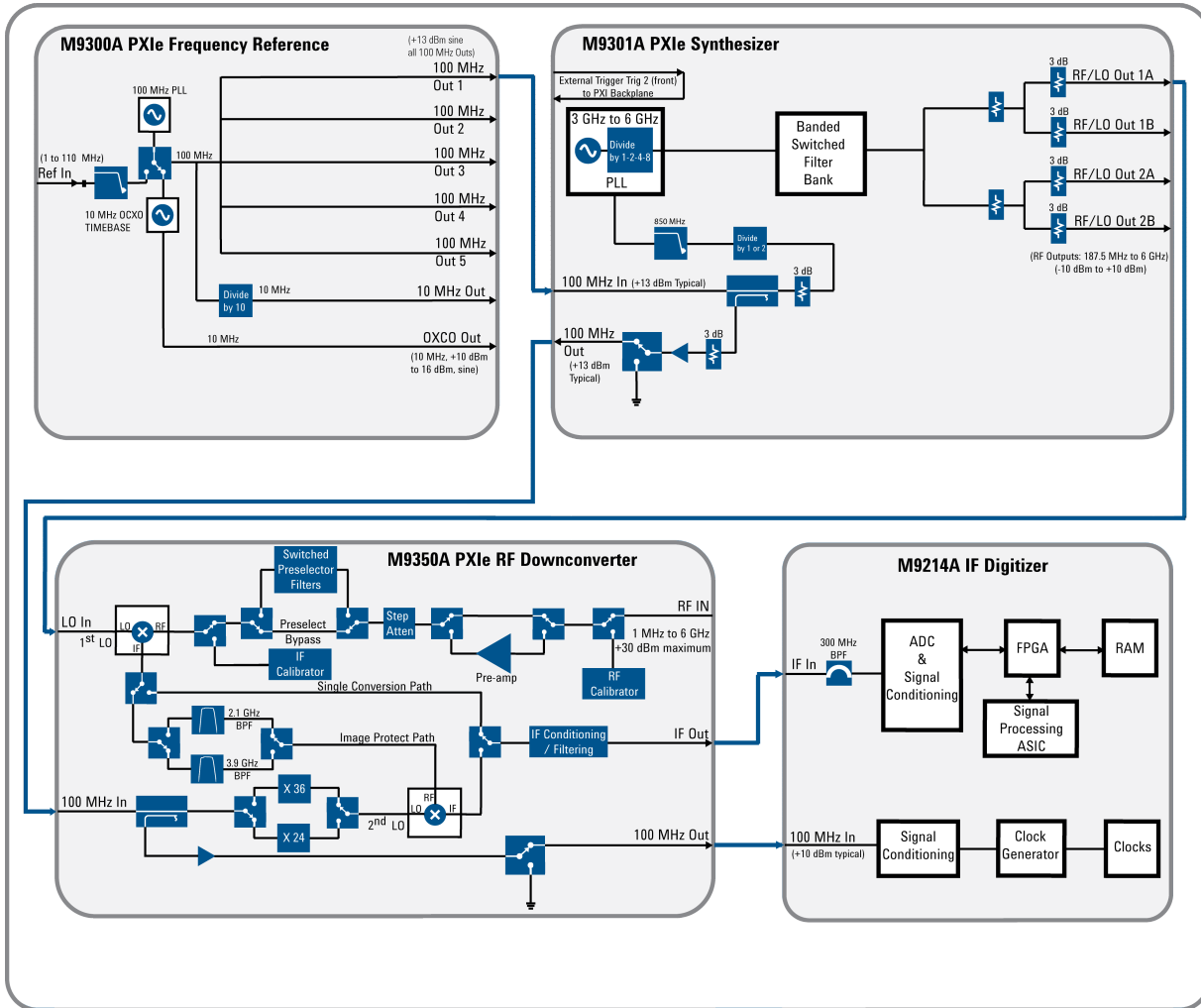

Block Diagram Reference Tables

M9391A Block Diagram Reference Table for M9300A

M9300A PXIe Reference Operation		
Input	Connector	Output
From: External Reference Frequency: 1 MHz to 110 MHz Input Level: -5 dBm to +20 dBm	Ref In	
	100 MHz Out 1-5	Frequency: 100 MHz Output level: >+12 dBm sine (+13 dBm typical)
	10 MHz Out	Output level: 3.3 Vpp square (1.65 v into 50 Ω)
	OCXO Out	Frequency: 10 MHz, AC coupled , 50 Ω source. Output level: +10 dBm to +16 dBm, from 10 MHz OCXO.
	Sync	This connector is intended for future use.
Sine or square wave -2 V to +5 V max into 50 Ω, +16 dBm max @ 0 VDC into 50 Ω	Trigger 1 & 2	3.3 V into 50 Ω
From : Chassis back plane board Frequency: 100 MHz	100 MHz BP Out	Frequency: 100 MHz Output level: +10 dBm

M9391A Block Diagram Reference Table for M9301A

M9301A PXIe Synthesizer Operation		
Input	Connector	Output
	RF/LO Out 1A, 1B, 2A, 2B	Frequency: 187.5 MHz to 6.0 GHz Output level: -10 dBm to +10 dBm
From: M9300A 100 MHz Out - frequency: 100 MHz, Amplitude: >+12 dBm	100 MHz In	
	100 MHz Out	Frequency: 100 MHz Output level: >+10 dBm (typical)
	Sync	This connector is intended for future use.
Sine or square wave -2 V to +5 V max into 50 Ω, +16 dBm max @ 0 VDC into 50 Ω	Trigger 1 & 2 (In/Out)	3.3 V into 50 Ω
Chassis back plane board	100 MHz BP Out	Frequency: 100 MHz Output level: >+10 dBm

Step 4: Install the Modules

M9391A Block Diagram Reference Table for M9350A

M9350A PXle Downconverter Operation		
Input	Connector	Output
Chassis back plane board	100 MHz BP Out	Frequency: 100 MHz Output level: >+10 dBm
Sine or square wave -2 V to +5 V max into 50 Ω, +16 dBm max @ 0 VDC into 50 Ω	Trigger 1 & 2 (In/Out)	3.3 V into 50 Ω
	Sync	This connector is intended for future use.
From: M9301A 100 MHz Out - frequency: 100 MHz, Amplitude: >+12 dBm	100 MHz In	
	100 MHz Out	To: M9214A 100 MHz In Frequency: 100 MHz Output level: >+10 dBm (typical)
From: M9301A Synthesizer RF/LO Out. Frequency: 187.5 MHz to 6 GHz Input level: -10 dBm to +10 dBm	LO In	
	IF Out	326 MHz (for 15 MHz BW), 240 MHz (for 40 MHz BW) or 300 MHz (for 160 MHz BW) +5 dBm
1 MHz to 6 GHz, +30 dBm maximum	RF In	

M9391A Block Diagram Reference Table for M9214A

M9214A PXle IF Digitizer Operation		
Input	Connector	Output
Sine or square wave -2 V to +5 V max into 50 Ω, +16 dBm max @ 0 VDC into 50 Ω	Trigger 1 & 2	3.3 V into 50 Ω
	Sync	This connector is intended for future use.
Frequency: 100 MHz, Amplitude: >+12 dBm	100 MHz In	
326 MHz (for 15 MHz BW), 240 MHz (for 40 MHz BW) or 300 MHz (for 160 MHz BW) +5 dBm	IF In	

M9381A Block Diagram

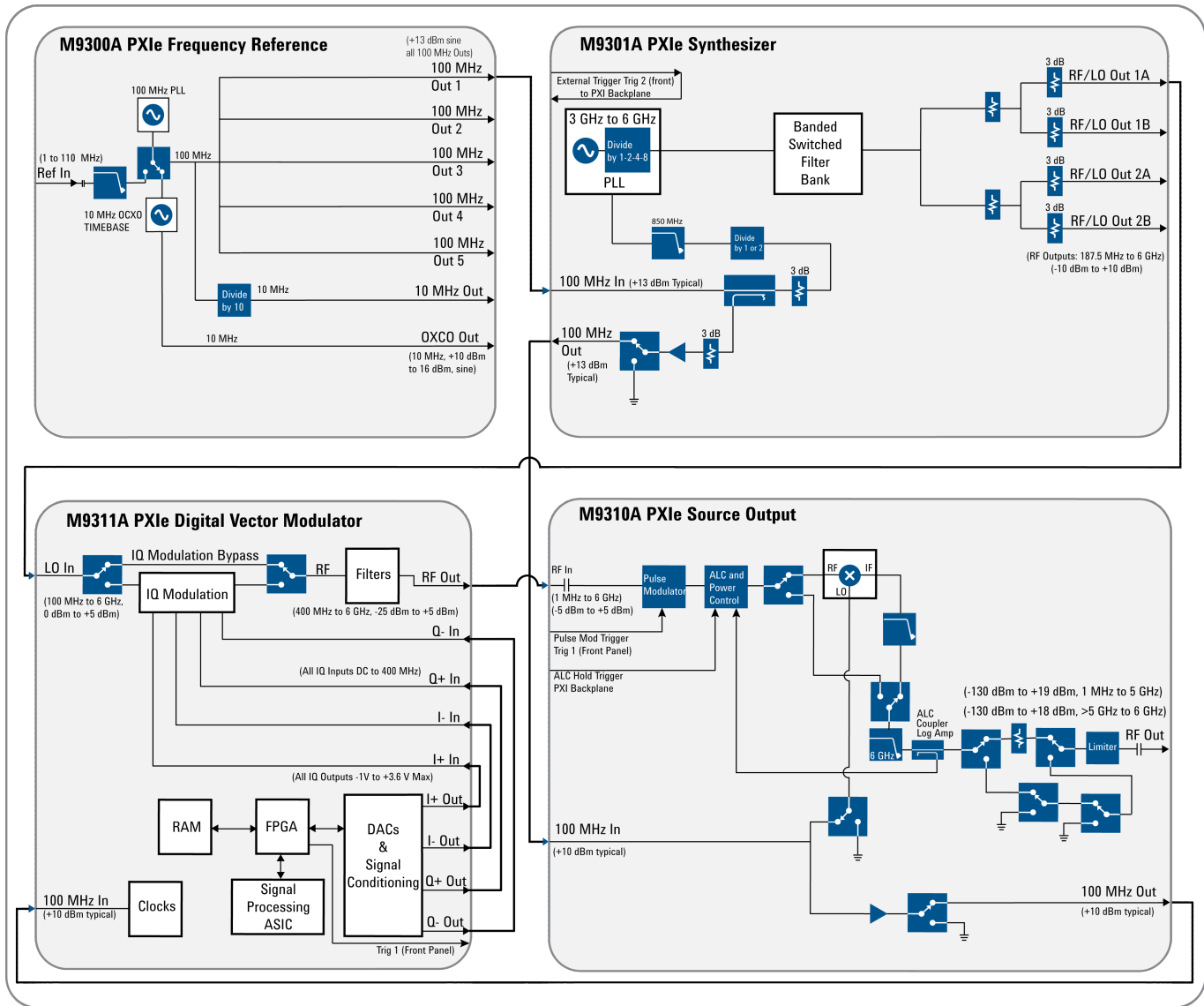

M9381A Block Diagram Reference Table for M9300A

M9300A PXIe Reference Operation		
Input	Connector	Output
From: External Reference Frequency: 1 MHz to 110 MHz Input Level: -5 dBm to +20 dBm	Ref In	
	100 MHz Out 1-5	Frequency: 100 MHz Output level: >+12 dBm sine (+13 dBm typical)
	10 MHz Out	Output level: 3.3 Vpp square (1.65 v into 50 Ω)
	OCXO Out	Frequency: 10 MHz, AC coupled, 50 Ω source. Output level: +10 dBm to +16 dBm, from 10 MHz OCXO.

Step 4: Install the Modules

M9300A PXIe Reference Operation		
Input	Connector	Output
	Sync	This connector is intended for future use.
Sine or square wave -2 V to +5 V max into 50 Ω, +16 dBm max @ 0 VDC into 50 Ω	Trigger 1 & 2 (In/Out)	3.3 V into 50 Ω
From : Chassis back plane board Frequency: 100 MHz	100 MHz BP Out	Frequency: 100 MHz Output level: +10 dBm

M9381A Block Diagram Reference Table for M9301A

M9301A PXIe Synthesizer Operation		
Input	Connector	Output
	RF/LO Out 1A, 1B, 2A, 2B	Frequency: 187.5 MHz to 6.0 GHz Output level: -10 dBm to +10 dBm
From: M9300A 100 MHz Out - frequency: 100 MHz, Amplitude: >+12 dBm @100 Hz: -130 dBc/Hz @1 kHz: -160 dBc/Hz	100 MHz In	
	100 MHz Out	To M9310A 100 MHz In Frequency: 100 MHz Output level: >+10 dBm (typical)
	Sync	This connector is intended for future use.
Sine or square wave -2 V to +5 V max into 50 Ω, +16 dBm max @ 0 VDC into 50 Ω	Trigger 1 & 2 (In/Out)	3.3 V into 50 Ω
Chassis back plane board	100 MHz BP Out	Frequency: 100 MHz Output level: >+10 dBm

M9381A Block Diagram Reference Table for M9310A

M9310A PXIe RF Output Operation		
Input	Connector	Output
	RF In	
	RF Out	Frequency: 1 MHz to 6 GHz Output level: -120 dBm to +10 dBm (standard power) Output level: +19 dBm (Option 1EA high power) for frequencies from 1 MHz to 5 GHz and +18 dBm for frequencies > 5 GHz to 6 GHz.
from: M9301A 100 MHz Out Frequency: 100 MHz Amplitude: >+12 dBm	100 MHz In	
	100 MHz Out	To M9311A 100 MHz In Frequency: 100 MHz Output level: >+10 dBm (typical)
	Sync	This connector is intended for future use
Sine or square wave -2 V to +5 V max into 50 Ω, +16 dBm max @ 0 VDC into 50 Ω	Trigger 1 & 2 (In/Out)	3.3 V into 50 Ω. Trig 1 Output .
Chassis back plane board	100 MHz BP Out	Frequency: 100 MHz Output level: >+10 dBm

M9381A Block Diagram Reference Table for M9311A

M9311A PXIe Digital Vector Modulator Operation		
Input	Connector	Output
From: M9301A Synthesizer RF/LO Out. Frequency: 187.5 MHz to 6 GHz Input level: 0 dBm to +5 dBm	LO In	
	RF Out	To M9310A RF In - Frequency: 400 MHz to 6 GHz Output power: -25 dBm to +5 dBm
100 MHz Reference from M9310A	100 MHz In	
	Sync	This connector is intended for future use.
Sine or square wave -2 V to +5 V max into 50 Ω , +16 dBm max @ 0 VDC into 50 Ω	Trigger 1 & 2 (In/Out)	3.3 V into 50 Ω Trig 1. Input from M9310A trig 1

Step 5: Verify Operation of the M9381A Vector Signal Generator and M9393A PXIe Vector Signal Analyzer

NOTE Use the following procedure to verify operation of a single channel VSG/VSA (M9381A and M9391A, or M9393A) configuration. See "Keysight 89600 Vector Signal Analysis Software for M9391A" on page 51.

1. Turn power on to the M9018A Chassis, if you haven't already.
2. The first step in this process is to conduct a Self Test of the M9381A and the M9391A.
 - a. Open the M9381A SFP by selecting **Start > All Programs > Keysight > M938x > M9381 SFP**.
 - b. Open the M9391A SFP by selecting **Start > All Programs > Keysight > M9391 > M9391 SFP** . or **Start > All Programs > Keysight > M9393 > M9393 SFP**
 - c. For each SFP, you are presented with the "Connect to Instrument" dialog. Use **Ctrl/Select** to select all of the modules that are components of the M9381A and press **Connect** and the M9391A. Leave the SFPs open. For example:

M9381A

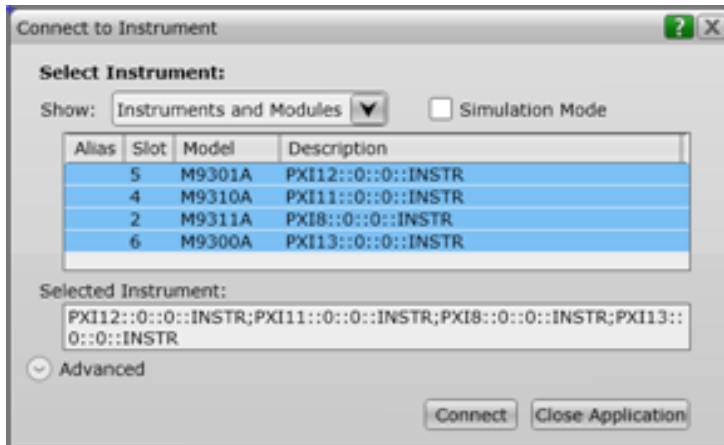

M9391A

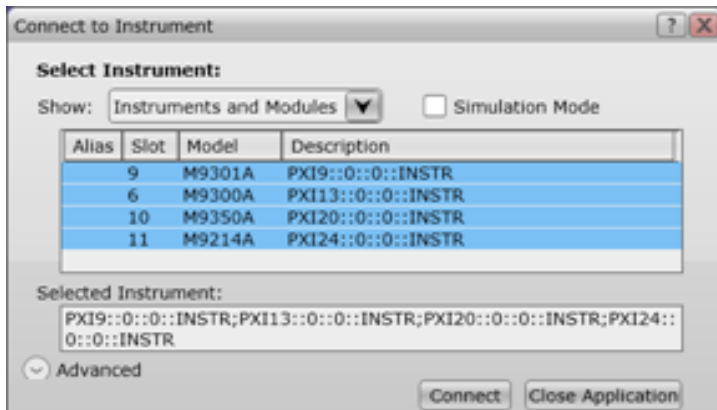

NOTE If not all modules and slot locations are visible in the SFP "Connect to Instrument" dialog, Close the SFP. See "Communications" on page 45

NOTE Selecting **Connect** initializes the instrument and all associated modules. Prior to initialization, all LEDs are off.

3. Check the front panel Status LEDs of all modules, according to the following table.

Status LED States

Module	Green	Orange	Red	Off
M9300A	The Soft Front Panel has initialized the connection to the module	n/a	Indicates that the VCXO is unlocked.	<ul style="list-style-type: none"> Not connected by the SFP. Failure in the power supplies. Module hardware health can't be determined until the power supply failure is resolved.
M9301A	The Soft Front Panel has initialized the connection to the module	Tuning is in progress, or the M9301A is unlocked from the reference.	n/a	<ul style="list-style-type: none"> Not connected by the SFP. Failure in the power supplies. Module hardware health can't be determined until the power supply failure is resolved.
M9310A	The Soft Front Panel has initialized the connection to the module	n/a	n/a	<ul style="list-style-type: none"> Not connected by the SFP. Failure in the power supplies. Module hardware health can't be determined until the power supply failure is resolved.
M9311A	<ul style="list-style-type: none"> The Soft Front Panel has initialized the connection to the module. The module has returned to idle from modulation. 	<ul style="list-style-type: none"> Modulation is turned on. 	<ul style="list-style-type: none"> DAC over-load detected. IQ over-load detected 	<ul style="list-style-type: none"> Not connected by the SFP. Failure in the power supplies. Module hardware health can't be determined until the power supply failure is resolved.
M9214A	The Soft Front Panel has initialized the connection to the module	Missing 100 MHz Reference.	n/a	<ul style="list-style-type: none"> Not connected by the SFP. Failure in the power supplies. Module hardware health can't be determined until the power supply failure is resolved.
M9350A	The Soft Front Panel has initialized the connection to the module	Missing 100 MHz Reference.	n/a	<ul style="list-style-type: none"> Not connected by the SFP. Failure in the power supplies. Module hardware health can't be determined until the power supply failure is resolved.

CAUTION

It is important that no signal is present at the RF Input of the Keysight M9350A PXIe Downconverter when doing a Self Test. If a signal is present, it may result in a false failure.

4. Conduct a Self Test on all modules of the M9391A and also the M9381A (**Utilities > Self Test... > Run Self Test**).

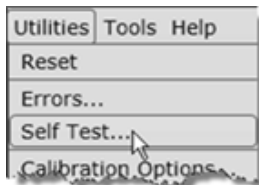

If the Self Test passes (see results below), go to [Step 6: Make a Measurement \(page 46\)](#).

Step 5: Verify Operation of the M9381A Vector Signal Generator and M9393A PXIe Vector Signal Analyzer

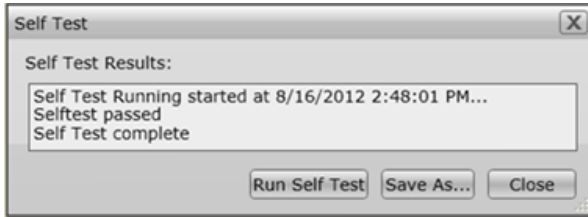

Self Test Failure

If the Self Test does not pass for any of the multi-module instruments, the test indicates which module is likely to need service. However, you should return all modules (except the M9300A) and all cables for that particular instrument. All component modules for an M9381A or M9391A MMI are factory tested and calibrated as a "bundle". It is important that you maintain the bundle when returning an MMI for repair.

To ensure that you send in the group of modules that was reported in a Self Test failure, go to **Utilities > Calibration Options...** to view this screen:

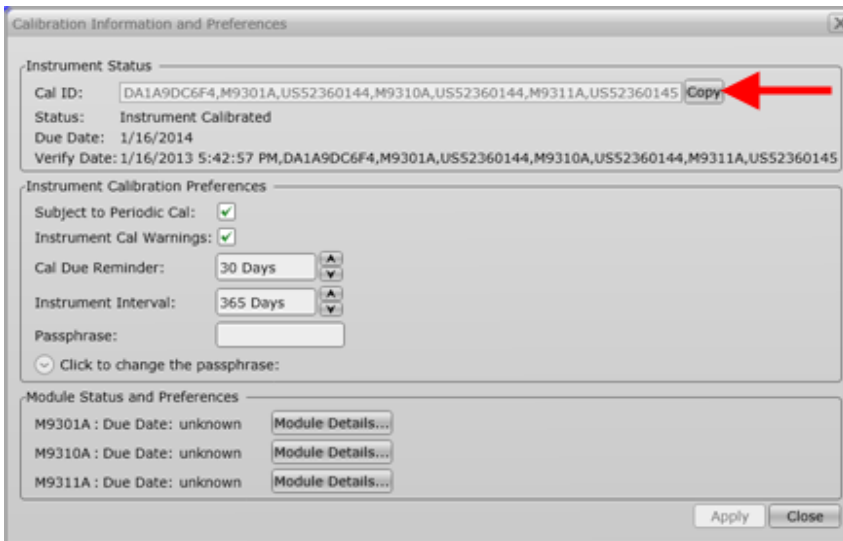

The string pointed out in this image is the Cal ID. The first 10 characters represent the Unique ID and the remaining characters show the modules (and their serial numbers) that constitute the M9381A or M9391A instrument. A Certificate of Calibration for that instrument contains the same information. Additionally, you may see this same information from the SFP by using **Help > About**.

See [Return an Instrument for Service \(page 12\)](#).

CAUTION

It is important that no signal is present at the RF Input of the Keysight M9350A PXIe Downconverter when doing a Self Test. If a signal is present, it may result in a false failure.

NOTE

If the Self Test reports backplane trigger errors, follow the PXI trigger bus reconfiguration instructions in [Configuring M9018A PXIe Backplane Triggers \(page 49\)](#).

Communications

If you are unable to communicate with the M9391A or M9381A verify that the following installations are correct:

- Keysight IO Libraries Suite
- M9381A and M9391A SFP programs
- Module and chassis drivers
- System Interface Card, cable and PC PXIe card connections, if you are using an external host PC

If not all modules and their slot locations are visible in the SFP "Connect to Instrument" dialog:

1. Close the SFP.
2. Start Keysight Connection Expert, by selecting **Start > All Programs > Keysight Connection Expert**. If any or all modules and their slot locations are still not visible, select **Refresh All**.
3. Restart the SFP.

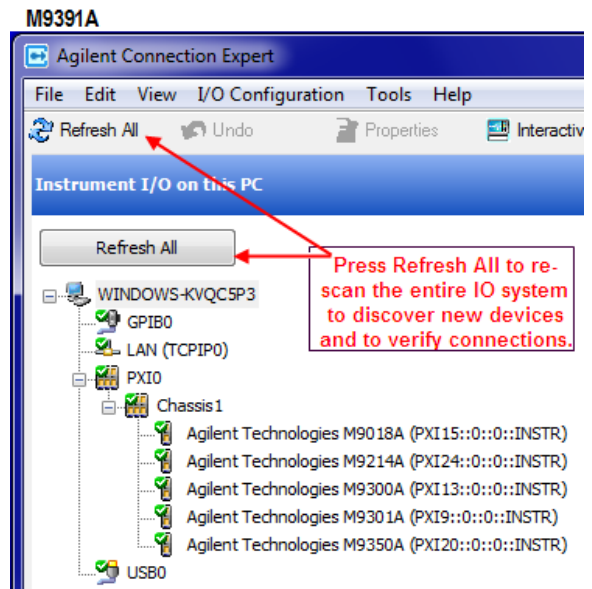
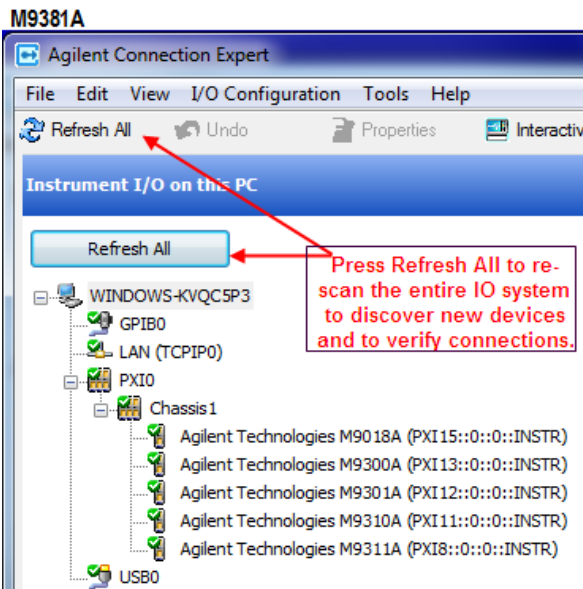

Step 6: Make a Measurement

NOTE As a best practice, always run a Self Test of each instrument before making a measurement..

NOTE If your solution has more than one channel, repeat this process for each channel.

1. The first step in this process is to open the SFP of the M9381A and the M9391A.
 - a. Open the M9381A SFP by selecting **Start > All Programs > Keysight > M938x > M9381 SFP**.
 - b. Open the M9391A SFP by selecting **Start > All Programs > Keysight > M9391 > M9391 SFP**.
 - c. For each SFP, you are presented with the "Connect to Instrument" dialog. Use **Ctrl/Select** to select all of the modules that are components of the M9381A and the and press **Connect**.
2. Connect a high quality SMA (male) to SMA (male) cable between the RF Out connector on the Keysight M9310A PXle Source Output and the RF In connector on the Keysight M9350A PXle Downconverter.
3. Torque the connectors to 8 Lb-In (0.904 Nm).
4. On the M9381A SFP make the following settings:

- a. Frequency: 2 GHz
- b. Amplitude: -10 dBm
- c. RF On: checked
- d. ALC On: checked.

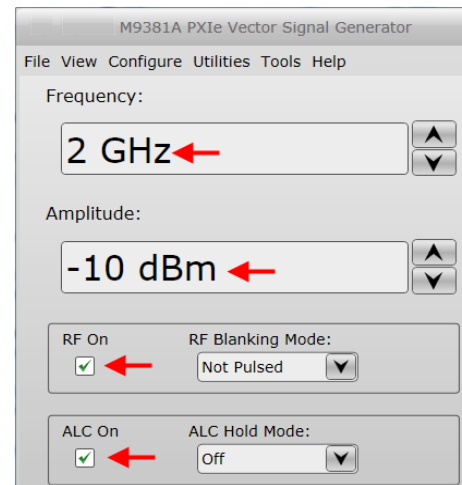

5. On the M9391A SFP Measure Tab, make the following settings:
 - a. Frequency: 2 GHz
 - b. Input Power: -10 dBm
 - c. Acquisition: Spectrum

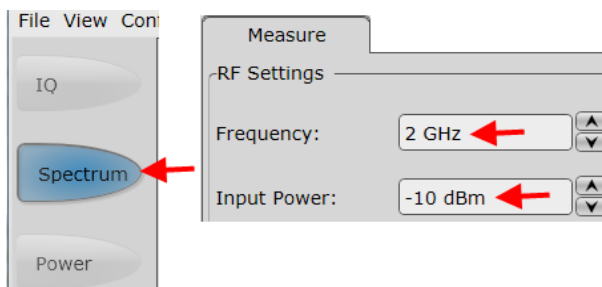

- Below the display, select Continuous for a sustained sweep of the analyzer.

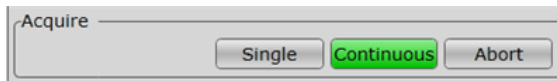

You should see the following display on your M9391A SFP. The frequency of the signal is 2 GHz and the amplitude is -10 dBm.

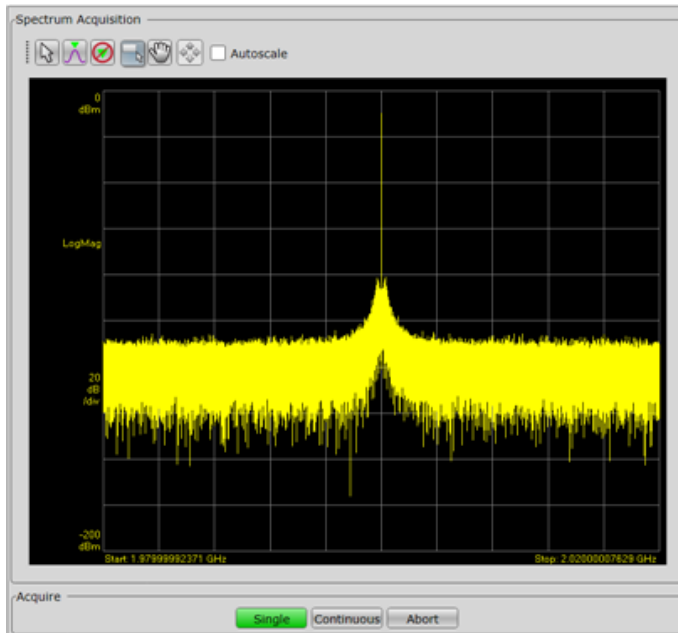

- Proceed to [Step 7: Installation is Complete \(page 47\)](#).

Step 7: Installation is Complete

Proceed to program your product by means of the applications programming interface (API) for the supplied drivers.

API Overview

IVI Drivers

Keysight's IVI drivers simplify the creation and maintenance of instrument control applications in a variety of development environments; they allow programmatic control of instrumentation while providing a greater degree of instrument interchangeability and code reuse. IVI drivers currently come in two basic types: IVI-COM and IVI-C. Although the functionality offered by both types of drivers is often very similar, the fundamental differences in interface technology results in a very different end-user experience. The IVI drivers support compiling application programs for 32- or 64-bit platforms.

Supported ADEs (application development environments) Arguably the most important consideration in comparing IVI-COM and IVI-C drivers is the end user experience in various ADEs. Since IVI-COM drivers are based on Microsoft COM technology, it's not surprising that IVI-COM drivers offer the richest user experience

in Microsoft ADEs. Users working in Visual C++, Visual C#, Visual Basic.NET, and Visual Basic 6 enjoy a host of features, such as object browsers, IntelliSense, and context-sensitive help.

When you install the product software, the IVI driver files are installed in the standard IVI Foundation directories (for example, C:\Program Files\IVI Foundation\IVI\Drivers\). Example programs are provided to demonstrate most driver functionality (for example, C:\Program Files\IVI Foundation\IVI\Drivers\Examples). The reference material for the driver functions (a Microsoft HTML Help .chm file) is installed with the IVI driver and is available for Microsoft Visual Studio's IntelliSense context linking. In addition, you can directly access the .chm file (AgM9391.chm, or) from this Start menu location: **Start > All Programs > Keysight IVI Drivers > AgM9391 VSA**, or **> Documentation**.

LabVIEW Driver

In addition to the IVI drivers, Keysight provides a LabVIEW driver that includes all the functionality of the IVI-C driver. When you install the product software, the LabVIEW driver is installed to each LabVIEW instr.lib directory for each version of LabVIEW you have on your computer (for example, C:\Program Files (x86)\National Instruments\<LabVIEW version>\instr.lib\<Agilent product model>). If you install LabVIEW drivers before you install LabVIEW itself, drivers will be installed in the Agilent directory instead of the National Instruments directory (for example, C:\Program Files (x86)\Agilent\<Agilent product model>\LabVIEW Driver\<LabVIEW version>\...). Example programs are provided to demonstrate most driver functionality. The reference information for the driver (a Microsoft HTML Help .chm file) is also installed with the driver and the content is available from LabVIEW's Context Help window. In addition, you can directly access the chm file (AgM9391 LabVIEW_Help, or) from this Start menu location: **Start > All Programs > Keysight > M9391** , or **> M9391 LabVIEW Help**, or .

SCPI Interface (M9380A and M9381A only)

Keysight provides a SCPI server for the M9380A and M9381A source instruments. To access the server from the Start menu, go to **Start > All Programs > Keysight > M938x > M938x SCPI Server**. The SCPI Reference is located at **Start > All Programs > Keysight > M938x > M938x SCPI Reference**.

M9391A and M9381A Specifications

Some specifications for component modules were adjusted following a manufacturing serial number break. Data sheets contain specifications for current production modules. Specification Guides contains serial number breaks where specifications were adjusted.

The Data Sheet and Specifications Guide for both the M9391A and the M9381A are included on the Keysight PXIe VSA & VSG M9391A VSA, M9381A VSG and M9380A CW Source Software and Product Information CD (M9300-10002) that came with your multi-module instruments (MMI). Please check the Keysight website at www.keysight.com/find/m9391a for the latest updates to the M9391A information. The Data Sheet for the M9391A can also be found at www.cp.literature.keysight.com/litweb/pdf/5991-2603EN.pdf. The Specifications Guide for the M9391A can also be found at www.cp.literature.keysight.com/litweb/pdf/M9391-90015.pdf

The Data Sheet and Specifications Guide for the M9381A are also available at www.keysight.com/find/m9381a. The Data Sheet for the M9381A can also be found at www.cp.literature.keysight.com/litweb/pdf/5991-0279EN.pdf. The Specification Guide for the M9381A The

Specifications Guide for the M9381A can also be found at www.cp-literature.keysight.com/litweb/pdf/M9381-90015.pdf.

Configuring M9018A PXIe Backplane Triggers

When using the Keysight M9018A PXIe 18-slot chassis, it is recommended that you install the M9381A modules entirely within one of the slot groups: 1 through 6, 7 through 12, or 13 through 18. If you install the M9381A modules straddling any of these groups of slots, you will have to reconfigure the chassis's PXIe trigger bus routing for trigger 6 and trigger 7.

Backplane Triggers Used

- PXIe backplane trigger 6 is used to route the External Trigger signal from the Keysight M9301A PXIe Synthesizer front panel to the Keysight M9311A PXIe Digital Vector Modulator. Trigger 6 can be reassigned using API hints. You can use backplane triggering directly to the M9311A (no M9301A involved) by selecting the External Trigger source to be PXIe trigger 0 to 7.
- PXIe backplane trigger 7 is used for routing the ALC Trigger signal from the Keysight M9311A PXIe Digital Vector Modulator to the Keysight M9310A PXIe Source Output. Although the default is PXIe trigger 7, it can be reassigned using API hints.

CAUTION

The Keysight M9018A PXIe Chassis does not remember the trigger bus configuration upon cycling power. After a power cycle, you must reconfigure the bus triggers by using the M9018A SFP or by creating a persistent configuration by using the AgM9018 API. Refer to the Keysight M9391A VSA and M9381A PXIe VSG Programming Guide (M9300-90080) for details and programming examples. This document is available on your installation CD and online at www.cp-literature.keysight.com/litweb/pdf/M9300-90080.pdf.

Procedure for Configuring PXIe Backplane Bus Triggers

1. Make sure you have followed Steps 1 through 4 in this Startup Guide to setup and configure the Keysight M9381A PXIe Vector Signal Generator.
2. Conduct a Self Test (**Utilities > Self Test... > Run Self Test**). If your configuration straddles two slot groups, you will receive error messages.

NOTE

In the following graphic a Self Test has been run on an M9381A that is installed in slots 5 through 9; therefore, it straddles two slot groups. The Self Test detects errors with backplane triggers 6 and 7.

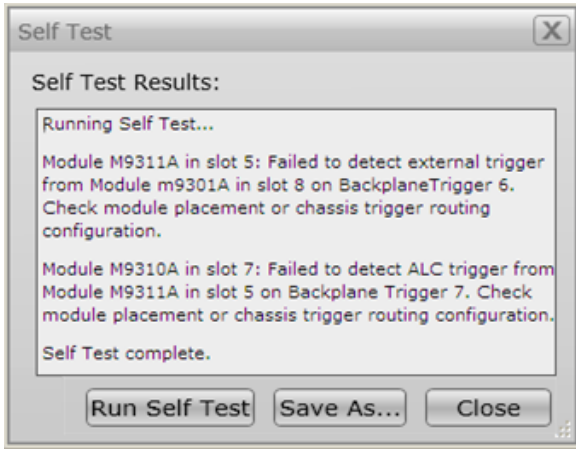

3. Open the M9018A SFP (Start > All Programs > Keysight > M9018 > M9018 SFP).
4. Select (enable) **Allow Control**.

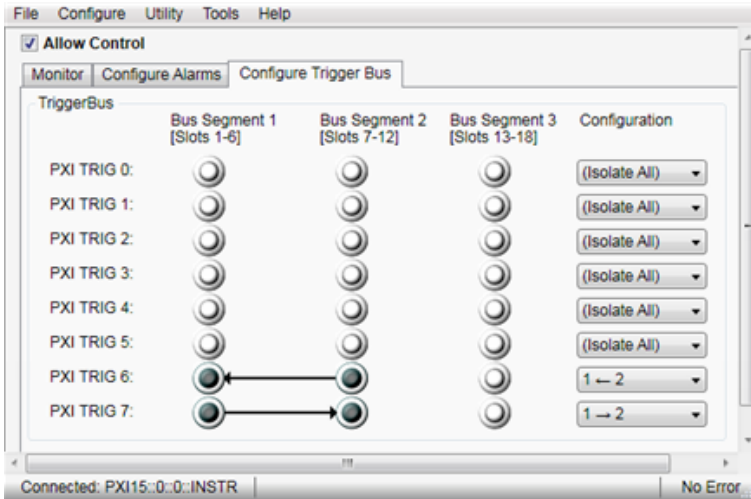

5. Trigger 6 routes the External Trigger signal from the M9301A to the M9311A. In this example, the M9301A has been installed in Slot 8 (Bus Segment 2), while the M9311A is in Slots 5 (Bus Segment 1). Therefore, backplane trigger 6 must be redirected from Bus Segment 2 to Bus Segment 1. Use the drop-down menu to select "1 ← 2".
6. Trigger 7 routes the ALC Trigger signal from the M9311A to the M9310A. Since the M9311A is now in Bus Segment 1 and the M9310A is in Bus Segment 2, backplane trigger 7 must be redirected from Bus Segment 1 to Bus Segment 2. Use the drop-down menu to select "1 → 2".

NOTE If two to four sources are installed in the M9018A chassis, each source should have its own backplane trigger line. If you have a source that spans segment 1 and segment 2 and another source that spans segment 2 and segment 3, using a single set of trigger lines with 1 → 2 → 3 and 1 ← 2 ← 3 does not work for both sources. In this case, you must configure one set of trigger lines with 1 → 2 and 1 ← 2 connections and another set of trigger lines with 2 → 3 and 2 ← 3 connections.

Keysight 89600 Vector Signal Analysis Software for M9391A

Overview

One of the components of Keysight M9391A PXIe Vector Signal Analyzer software installation is the Keysight 89600 VSA software role, or hardware extension. A role is a set of DLL files that is an interface between the 89600 VSA software and acquisition hardware. The role files, as well as an integration utility, are installed along with other M9391A program files. The M9391A installer runs the integration utility which detects if 89600 VSA software is installed, and if so, copies the M9391A role files into the program files for each compatible version of 89600 VSA.

NOTE If the Keysight 89600 VSA software is installed after the M9391A drivers, you need to run the 89600 VSA integration utility. Go to **Start > All Programs > Keysight > M9391 > 89600 VSA Integration**.

A role DLL implements several COM interfaces. The interfaces have methods for acquiring measurement hardware, setting acquisition parameters, querying data and querying hardware status. The M9391 role is a layer mapping COM interface methods to M9391 interface methods.

Presence of the role allows 89600 VSA software to detect and configure modules for an M9391A receiver. The 89600 VSA's Hardware Configurations dialog is used to specify which modules form an instrument.

To use the Keysight 89600 VSA Software measurement capabilities, you must first create a connection between the measurement software and the hardware configuration that is your M9391A Vector Signal Analyzer.

NOTE The minimum required version of Keysight 89600 VSA software is 16.01.254.0. You can find this online at www.keysight.com/find/89600.

NOTE As a best practice, after setting up an M9391A measurement, perform a Disconnect/Restart (**Control > Disconnect** and then **Restart**). If there is an unlocked Frequency Reference or Digitizer 100 MHz clock missing condition, the M9214A Digitizer status LED will turn to Red and the INT REF indicator at the bottom of the display will indicate "UNLOCKED" or "Waiting for Frequency Reference Lock". At this point, troubleshoot the instrument cabling. Perform a Disconnect/Restart again to verify that the frequency reference is present. Whether the problem is a broken 100 MHz clock path or an invalid External Reference (either not present or mismatched frequency), the reference status and measurement status messages are the same - "UNLOCKED" reference and "Waiting for frequency reference" measurement status. However, if the external reference signal (not the 100 MHz clock) is invalid, as soon as the signal becomes valid, measurement will resume; whereas in the 100 MHz clock signal case, you must **Disconnect** from the hardware and then reconnect (**Restart**) to start the measurement again.

Procedure for a Single Channel Configuration

This procedure is for setting up and configuring a single channel system.

To create a new M9391A instrument, use the Keysight 89600 VSA Software and follow these steps:

1. Open the "New Hardware Configuration" window in the Keysight 89600 VSA software by selecting: **Utilities > Hardware > Configurations** from the menu bar. When you hover over the last element in this sequence you will see a listing of the relevant configurations. Click on the "Add New Hardware" icon .

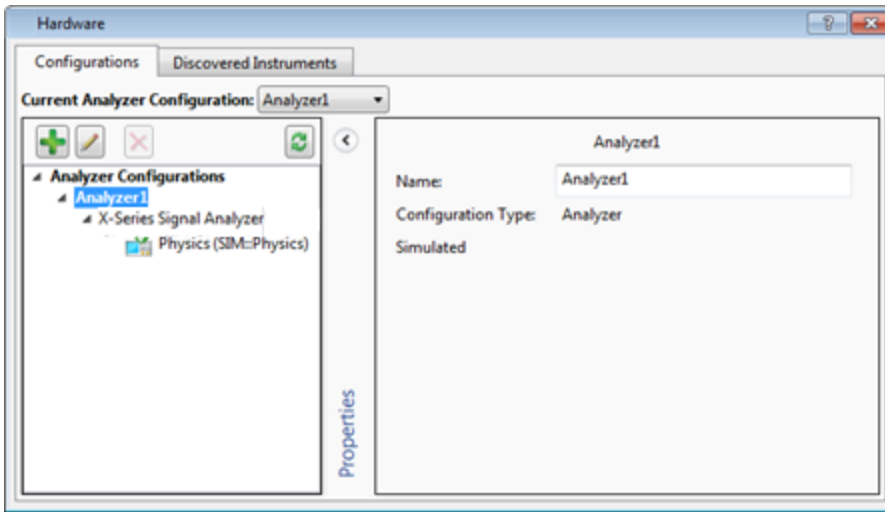

2. In the "New Hardware Configuration" window:

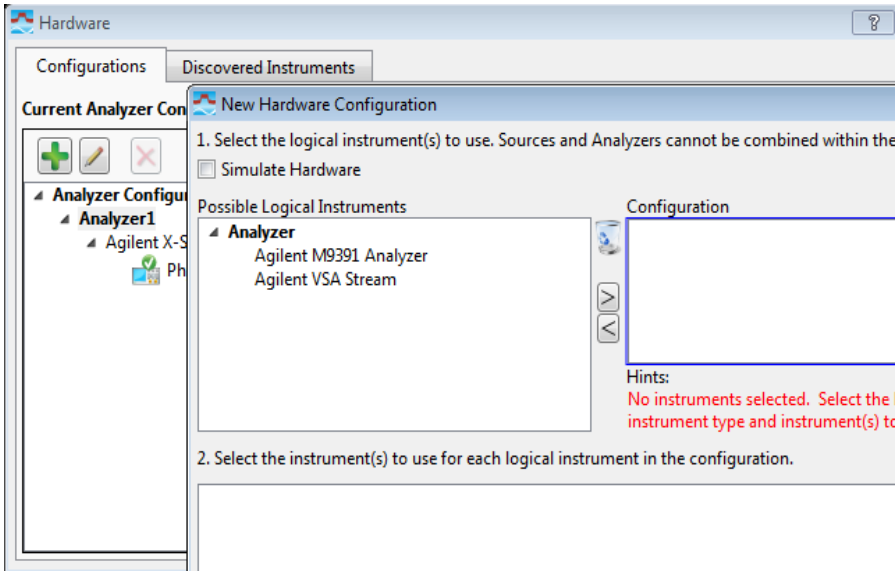

- a. Select the Keysight M9391A Analyzer entry and click on the  icon to copy the entry to the "Configuration" window.

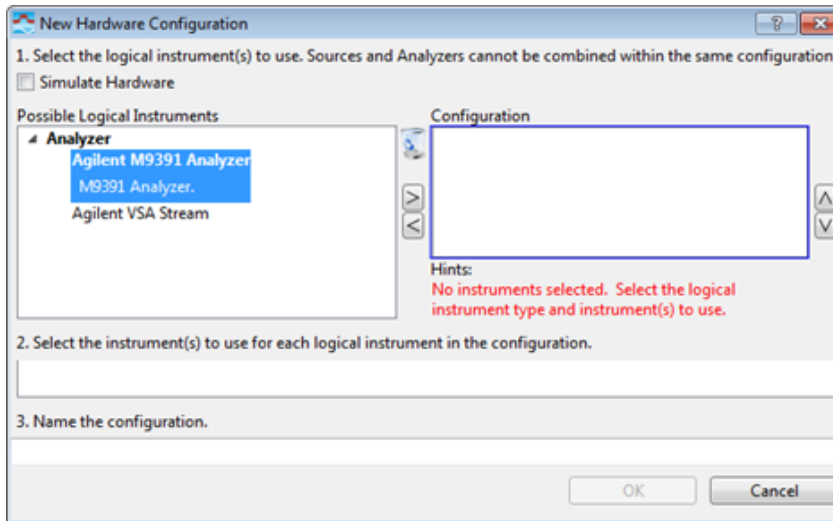

- b. Configure the new M9391A instrument by selecting the modules identified by their VISA address in the "2. Select the instrument(s) to use for each logical instrument in the configuration" section.

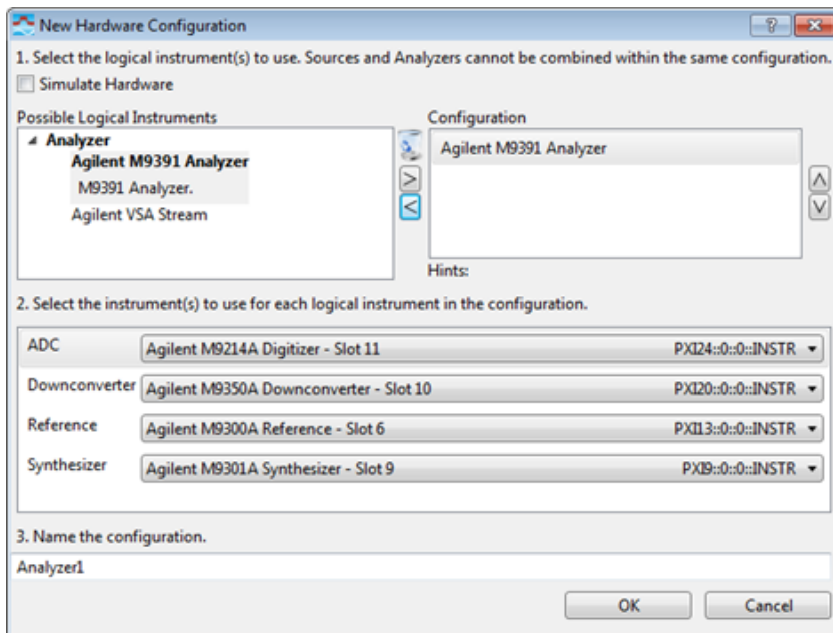

- c. Name the new configuration in the "3. Name the configuration" section. The default name "Analyzer1" may be changed. Use a meaningful name for later identification.
- d. Save the new configuration by selecting the "OK" button.

Refer to the [Keysight 89600 Vector Signal Analysis Software](#) for further details about making measurements with your Keysight M9391A PXIe Vector Signal Analyzer.

Parameter Control and Input Extensions

The Keysight 89600 role allows the VSA software to set the following parameters:

- Expected Input Power (Range)
- Center Frequency
- Bandwidth
- Acquisition Time
- Trigger Style (Free Run, External, IF Mag)
- Trigger Delay
- Trigger Slope
- Trigger Level

Extensions

Input extensions are the hardware configuration and setup parameters that apply to the Keysight 89600 VSA software with M9391A. To modify a hardware parameter, open the input extension dialog (**Input > Extensions** tab), click the parameter name and specify the value. For True/False values, a selected check box sets the value to True. A cleared check box sets the value to False.

Extensions:

- ADC Dither (to improve small signal performance) {On, Off}
- Conversion (to set mixer conversion type) {Auto, Image Protect, SingleHighSide, SingleLowSide}
- External Trigger Termination {HighImpedance, 50 Ohm}
- Magnitude Trigger Bandwidth {Normal, Wideband}
- Mixer Level Offset (dB, relative to default)
- Peak to Average (ratio of expected input signal, used to adjust IF gain and mixer level)
- Phase Noise Optimization {Normal, BestWideOffset}
- Preamplifier {Auto, Off, On}
- Time Average Count
- Time Average Period (Seconds)
- TTL Trigger location (PXI_TRIG0...PXI_TRIG7)

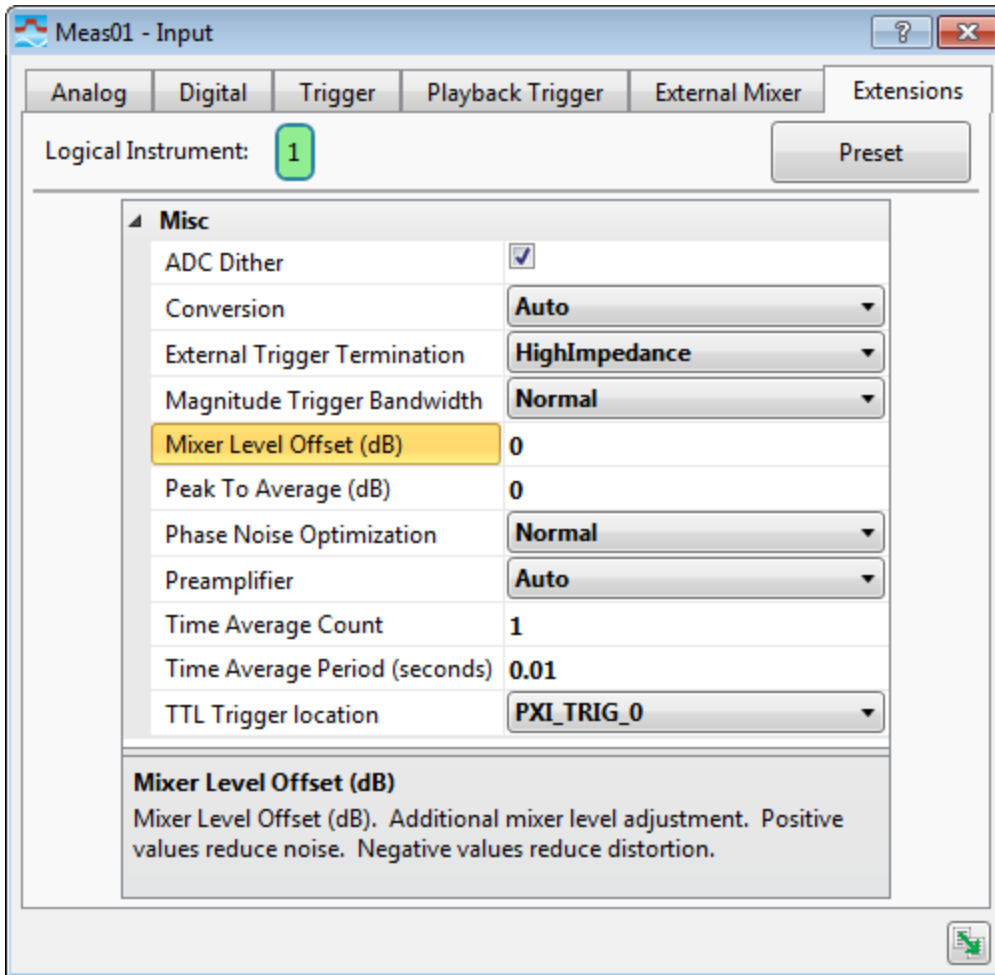
**NOTE**

For additional information on each extension item, highlight the item and a summary is displayed near the bottom of the extension dialog box.

